



HAILO Einbautechnik.

Abfalltrenn- und Ordnungssysteme für Küche und Hauswirtschaftsraum.

Waste separation and organizer systems for the kitchen and utility room.

Gesamtkatalog
Complete Product Range

2024/2025



Willkommen.

in der Welt von HAILO Einbautechnik.

Lassen Sie sich inspirieren von unserem umfangreichen Programm an komfortablen, nützlichen Einbausystemen für die Küche und den Hauswirtschaftsraum.

Lesen Sie auch die Einstiegsseiten, auf denen Sie Wissenswertes über HAILO erfahren.

Ihr Team von HAILO Einbautechnik

Welcome.

to the world of HAILO Built-In Technology.

Be inspired by our extensive range of convenient, useful built-in systems for the kitchen and utility room.

You can also read the introductory pages, where you can find out some interesting facts about HAILO.

Your HAILO Built-In Technology Team

Der rote Punkt ist unser Markenzeichen.

The red dot is our trademark.

HAILO steht seit Generationen für Qualitätsprodukte, die das Leben und Arbeiten im Haushalt angenehmer gestalten. Der rote Punkt von HAILO symbolisiert Qualität, Innovation, Sicherheit und gutes Design. Über 75 Jahre hinweg haben die Produkte von HAILO Menschen weltweit im privaten Haushalt und im Beruf begleitet, dabei Komfort und Arbeitssicherheit geboten. Die Marke HAILO hat sich durch langjähriges Know-how und die fortwährende Berücksichtigung der Kundenbedürfnisse einen Namen gemacht, dem sowohl private Anwender als auch Profis vertrauen.

Seit der Gründung im Jahr 1947 sind bei HAILO Vision, Pioniergeist, Innovationsfreude, Qualitätsbewusstsein und soziale Verantwortung untrennbar miteinander verbunden. Wir bieten zuverlässige Problemlösungen mit funktionellem, attraktivem Design in Top-Qualität. Als Erfinder der Aluminium-Haushaltsleiter und spezieller Abfallsammellösungen in Haushalt und Gewerbe ist HAILO in den Bereichen home & business, Kücheneinbautechnik und Professional stets einen Schritt voraus. Der ständige Antrieb von HAILO ist die Entwicklung innovativer und nutzbringender Produktlösungen, die den Bedürfnissen der Kunden gerecht werden.



For generations, HAILO has stood for quality products that make life and work in the household more pleasant. The HAILO red dot symbolises quality, innovation, safety and good design. For over 75 years, HAILO products have accompanied people around the world in their private households, offering convenience and safety at work. The HAILO brand has made a name for itself through many years of expertise and continuous consideration of customer needs, and is trusted by both private users and professionals.

Since its foundation in 1947, HAILO's vision, pioneering and innovative spirit, quality awareness and social responsibility have been inextricably linked. We offer reliable problem solutions with functional, attractive design in top quality. As the inventor of the aluminium household ladder and special waste collection solutions for households and businesses, HAILO is always one step ahead in the areas of home & business, built-in kitchen technology and professional. HAILO is constantly driven by the development of innovative and useful product solutions that fulfil the needs of its customers.

Drei starke Bereiche.

Three strong business divisions.

HAILO Einbautechnik.

HAILO Einbautechnik ist Systemlieferant der Küchenindustrie mit hochwertigen Abfalltrenn- und Ordnungssystemen.

Unsere Produkte: Einbau-Abfallsammler, Abfalltrennsysteme, Ordnungssysteme, Funktionssysteme, Einbau-Ausziehtische, Einbau-Klappritte, Einbaumodule für den Hauswirtschaftsraum

HAILO Built-In Technology is a system supplier to the kitchen industry with high-quality waste separation and organisation systems.

Our products: Built-in waste bins, waste separation systems, organizer systems, functional systems, built-in pull-out tables, built-in folding steps, built-in modules for the utility room.





HAILO home & business.

Im Bereich home & business bietet HAILO für Haushalt, Heim- und Handwerken ein umfassendes Sortiment bei Stand-Abfallsammeln aus Metall und ist in Europa marktführend bei Steiggeräten.

Unsere Produkte: Trittleitern, Stehleitern, Leiternpodeste, Sprossenleitern, Gerüste, Mülleimer.

In the home & business sector, HAILO offers a comprehensive range of metal waste bins for households, DIY and tradesmen and is the market leader in Europe for waste bins.

Our products: Folding steps, Step ladders, Ladder platforms, Rung ladders, Scaffolds, Waste bins.

HAILO Professional.

HAILO Professional ist der Spezialist, wenn es um Sicherheit beim Steigen geht. Unser Sortiment umfasst Steigtechnik und Zugangssicherungen für Gebäude, Schächte, Türme und maschinelle Anlagen aller Art.

Unsere Produkte: Steigleitern, Steigschutzsysteme, Schacht-abdeckungen, Schachtleitern, Schacht-Einstieghilfen, Podeste, Servicelifte, Schulungen

HAILO Professional is the specialist when it comes to climbing safety. Our range includes access technology and access guarding for buildings, shafts, towers and mechanical installations of all kinds.

Our products: Fixed ladders, climbing protection systems, shaft covers, shaft ladders, shaft access aids, platforms, service lifts, training courses



Ausgezeichnet.

Awarded.

Seit unserer Gründung im Jahr 1947 hat HAILO stets die Messlatte für Sicherheit und Innovation höher gelegt. Wir haben hart daran gearbeitet, Produkte zu entwickeln, die nicht nur funktional sind, sondern auch ästhetisch ansprechend und von höchster Qualität. Unsere Anstrengungen wurden durch zahlreiche renommierte Auszeichnungen gewürdigt, die uns als Vorreiter in vielen Bereichen bestätigen. Diese Auszeichnungen sind nicht nur eine Anerkennung unserer Vergangenheit, sondern auch ein Ansporn, weiterhin neue Maßstäbe zu setzen und die Erwartungen unserer Kunden zu übertreffen. HAILO bleibt auch in Zukunft bestrebt, durch Innovation, Qualität und Design zu begeistern und zu inspirieren.

Since our foundation in 1947, HAILO has always raised the bar for safety and innovation. We have worked hard to develop products that are not only functional, but also aesthetically pleasing and of the highest quality. Our efforts have been recognised by numerous prestigious awards, confirming us as a pioneer in many areas. These awards are not only a recognition of our past, but also an incentive to continue to set new standards and exceed our customers' expectations. HAILO will continue to strive to excite and inspire through innovation, quality and design.



RAT FÜR FORMGEBUNG

Die großen deutschen Marken 2024
The Major German Brands 2024



FOCUS MONEY

Unternehmen des Jahres 2024 | Kundenzufriedenheit
Company of the year 2024 | Customer satisfaction



PLUS X AWARD

Höchste Kundenzufriedenheit 2024 (Leitern)
Best customer satisfaction 2024 (ladders)

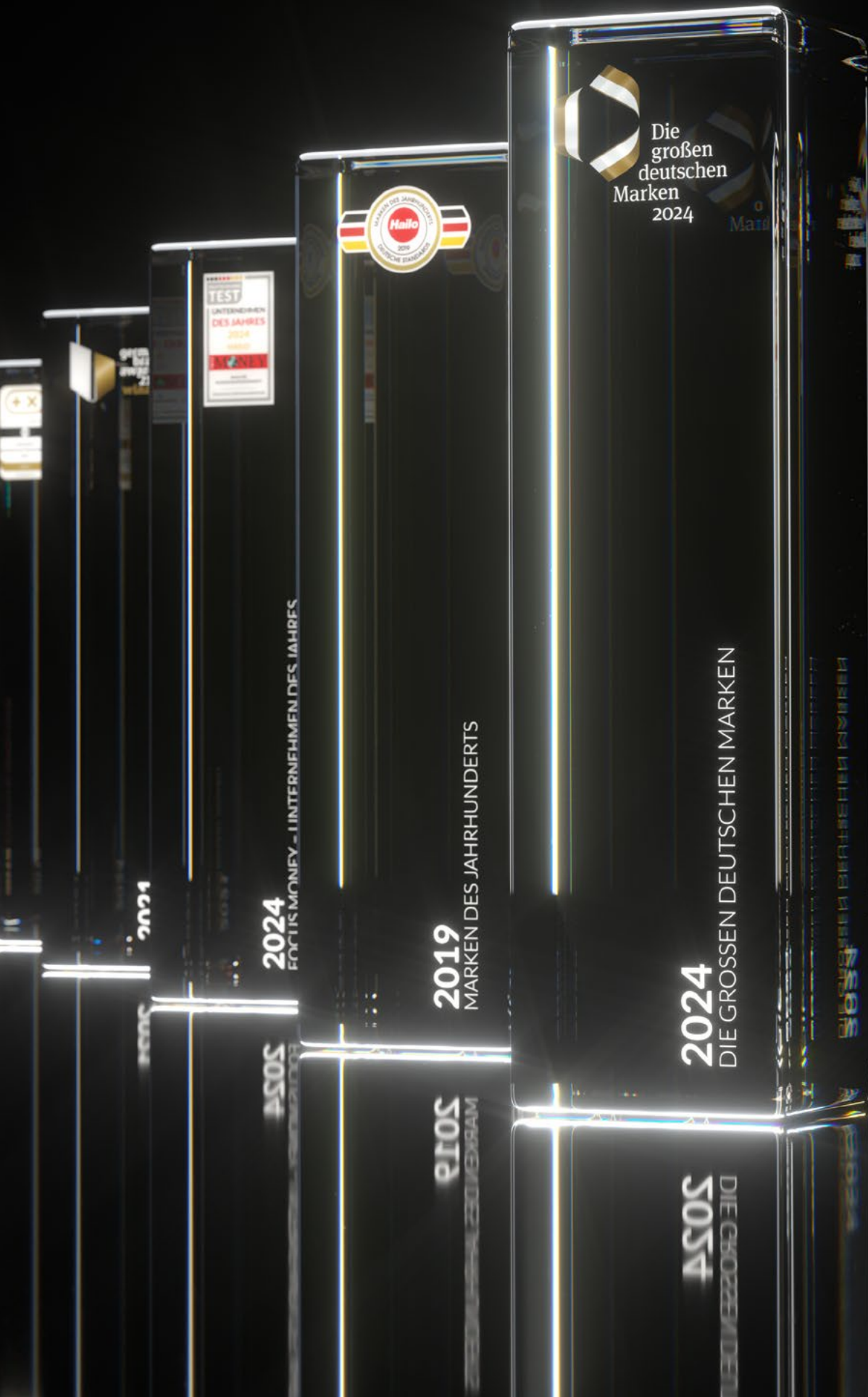

2024

2024
FOCUS MONEY - 1. INTERNEHMEN DES JAHRES

2019
MARKEN DES JAHRHUNDERTS

2024
DIE GROSSEN DEUTSCHEN MARKEN

Die großen deutschen Marken 2024



Passgenau.

Perfect fit.

Unsere innovativen Lösungen für die Küche von morgen kombinieren herausragendes Design und höchste Funktionalität. Durch die Integration neuer Technologien und die voranschreitende Digitalisierung wird jeder Millimeter sorgfältig geplant und jeder Raum optimal genutzt. Wir gestalten Einbaulösungen mit modernen Funktionen, die den Anforderungen des digitalen Zeitalters und des modernen Lebens gerecht werden.

HAILO Einbautechnik – wir setzen Trends.

Our innovative solutions for the kitchen of tomorrow combine outstanding design and maximum functionality. By integrating new technologies and advancing digitalisation, every millimetre is carefully planned and every space is used optimally. We design built-in solutions with modern functions that meet the requirements of the digital age and modern life.

HAILO Built-In Technology – we set trends.



Mit Leidenschaft.

With passion.



Bei uns verbinden sich langjährige Erfahrung und leidenschaftliches Engagement zu einer unschlagbaren Kombination. Wir setzen nicht nur auf Fachwissen, sondern auch auf Herzblut, um einzigartige Einbaulösungen zu schaffen. Bei HAILO Einbautechnik definieren wir Maßstäbe neu und lassen unsere Leidenschaft für Qualität in jedem Projekt aufleben.

We combine many years of experience and passionate commitment to create an unbeatable combination. We rely not only on expertise, but also on passion to create unique installation solutions. At HAILO Built-In Technology, we redefine standards and bring our passion for quality to life in every project.



Immer greifbar.

Always at hand.

HAILO Einbautechnik ist auf den für unsere Kunden relevanten Messen präsent. Hier zeigen wir einen repräsentativen Auszug aus unserem umfangreichen Produktportfolio. Hier stehen wir mit kompetentem Personal für Fachgespräche bereit. Hier werden zusammen mit Ihnen, bei Bedarf, Neuheiten besprochen und entwickelt.

Auf der Interzum in Köln und der SICAM in Pordenone stellen wir regelmäßig aus und laden Sie herzlich ein, uns dort zu besuchen.

HAILO Built-In Technology attends trade fairs that are relevant to our customers. This is where we exhibit a representative selection of our comprehensive product portfolio. It is where our professional staff are waiting to discuss your specific needs. And it is where - together with you - new products and services are discussed and developed as required.

We regularly exhibit at Interzum in Cologne and SICAM in Pordenone and invite you to visit us there.





Übersichtliche Vielfalt

Auf der HAILO Website bieten wir Industrie, Handel und Endkunden gleichermaßen nützliche Informationen zu unseren Produkten und Leistungen.

Egal ob Sie per Suchmaske die Artikelnummer oder den Produktnamen eingeben oder ob Sie über die Text- bzw. Bildnavigation etwas suchen – viele Wege führen Sie zur gewünschten Information.

Clean diversity

On the HAILO website, we provide industry, trade and end customers with useful information on our products and services in equal measure.

There are many ways to access the information you require: you can enter either the item number or the product name into the search screen or search for something via the navigation bar by text or by image.

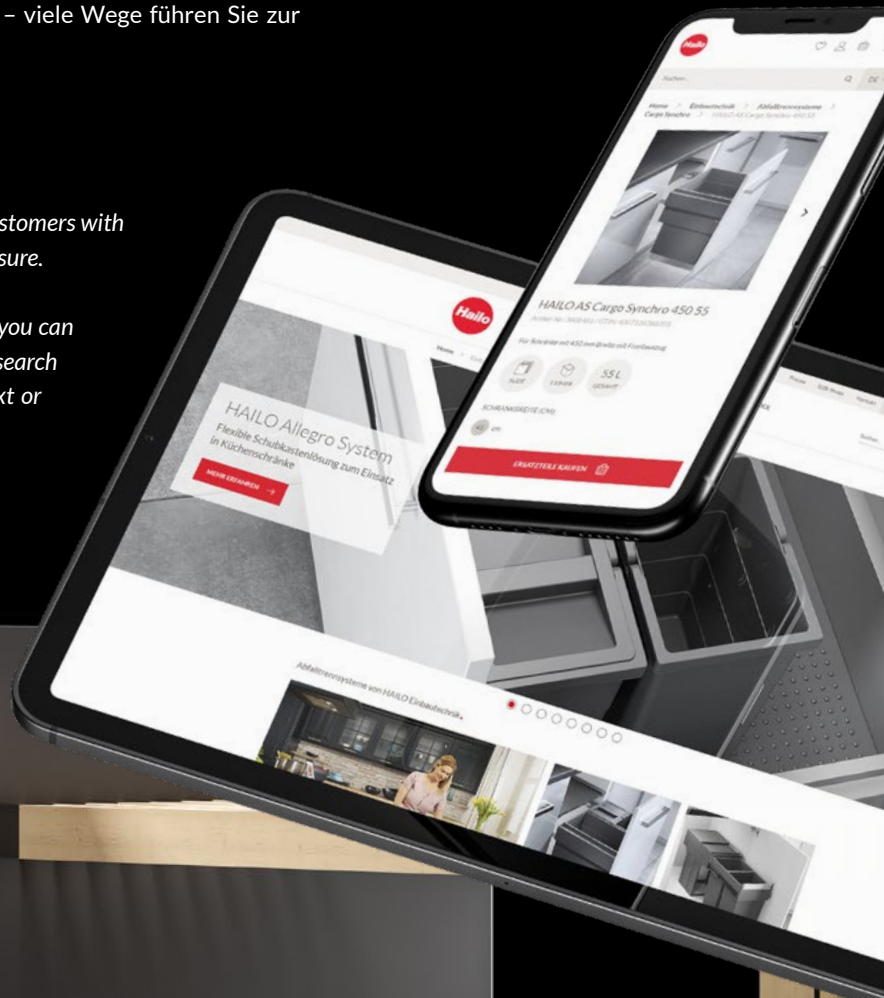



Nachhaltig.

Sustainable.

HAILO bietet auch Abfalltrennsysteme aus recycelten Kunststoffen an.

HAILO also offers waste separation systems made from recycled plastics.

Handlungsfelder unserer Nachhaltigkeitsstrategie.

Fields of action of our sustainability strategy.

Bei HAILO verstehen wir Nachhaltigkeit als langfristigen Unternehmenswert und als Verantwortung gegenüber unseren Mitarbeitern, Kunden und Partnern. Um die Bedeutung der Nachhaltigkeit zu verdeutlichen, ist sie zum einen zentraler Gegenstand unserer Strategie und zum anderen bereits richtungsweisend im Umgang mit Ressourcen.

At HAILO, we understand sustainability as a long-term corporate value and as a responsibility towards our employees, customers and partners. To illustrate the importance of sustainability, it is on the one hand a central object of our strategy and on the other hand already giving direction to the handling of resources.

Unternehmensstrategie: Nachhaltigkeit
Corporate strategy: Sustainability

Nachhaltige Verpackungslösungen
Sustainable packaging solutions

Optimierter Ressourcenverbrauch
Optimised resource consumption

CO₂-neutraler Versand
CO₂-neutral shipping



HAILO erhält erneut EcoVadis-Auszeichnung in Silber.

HAILO has received silver EcoVadis award again.

Wir freuen uns sehr über das erneute Silber-Rating von EcoVadis als Anerkennung für unser verantwortungsvolles Handeln. Dies bestätigt uns darin, weiterhin Ressourcen in einen nachhaltigen wirtschaftlichen Erfolg zu investieren.

We are very pleased about the repeated silver rating from EcoVadis as recognition for our responsible actions. This is what reassures us to invest resources in a sustainable economic success even in future.

Die vier Säulen der Corporate Social Responsibility
The four key factors of corporate social responsibility

- ✓ **Umwelt**
Environment
- ✓ **Arbeits- und Menschenrechte**
Labour and human rights
- ✓ **Ethik**
Ethics
- ✓ **Nachhaltige Beschaffung**
Sustainable procurement

Energie- und Strommanagement.

Energy and power management.

Bei HAILO verfolgen wir das Ziel, Kosten zu senken und Ressourcen zu schonen durch effizientes Energie- und Strommanagement. Dies umfasst Zertifizierungen zur regelmäßigen Überprüfung, die Förderung von umweltfreundlicher E-Mobilität im Fuhrpark und unsere eigene Stromerzeugung durch ein Blockheizkraftwerk sowie Photovoltaik für die Produktionsprozesse.

At HAILO, we pursue the goal of reducing costs and conserving resources through efficient energy and power management. This includes certifications for regular audits, the promotion of environmentally friendly e-mobility in the vehicle fleet and our own electricity generation through a combined heat and power plant and photovoltaics for the production processes.



Energiemanagement ISO 50001
Energy Management ISO 50001

Verwendung von ökologisch erzeugtem Strom
Use of ecologically generated electricity

Förderung umweltfreundlicher E-Mobilität
Promoting environmentally friendly e-mobility

Blockheizkraftwerk und Photovoltaikanlage zur eigenen Stromerzeugung
Combined heat and power plant and photovoltaic system for own electricity generation



Mehr zum Thema Nachhaltigkeit erfahren Sie auf unserer Website.
Find out more about sustainability on our website.

Kooperationen zum Thema Nachhaltigkeit.

Cooperations on the topic of sustainability.



Baumpatenschaft für 11.000 Bäume
Tree sponsorship for 11,000 trees



Kooperation mit „grünergriff“ Möbelhandel
Cooperation with "grünergriff" furniture trade



„Wege zum klimaneutralen Unternehmen“
"Ways to climate-neutral company"



Kampagne „Mülltrennung wirkt“
Campaign "Waste separation works"

Montagefreundlichkeit und Service.

Ease of installation and service.



Übersichtliche Montageanleitungen

Jedem HAILO Einbauprodukt liegt eine übersichtliche, bebilderte Montageanleitung bei.

Clear and illustrated installation instructions

All HAILO built-in-products are supplied with a clear installation instruction.



Montagevideos

In verschiedenen Montagevideos werden alle nötigen Arbeitsschritte anschaulich dargestellt. Diese Videos finden Sie in der Mediendatenbank unserer Website oder im YouTube Channel der HAILO Einbautechnik.

Installation videos

All these essential steps are clearly presented in different installation videos. You can download the video on the HAILO Built-In Technology website or simply view it at the YouTube channel of HAILO Built-In Technology.

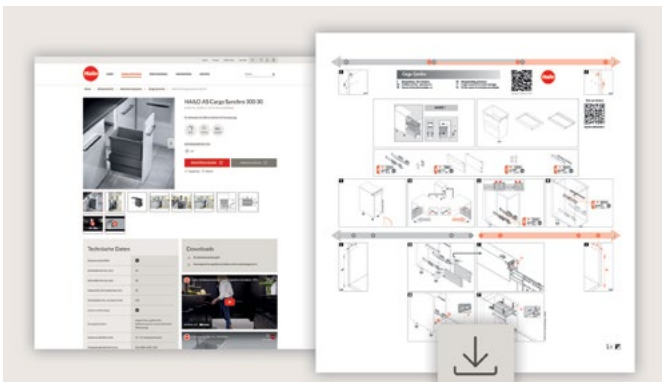

Montageanleitungen als PDF-Download

Auf der HAILO-Website stehen alle Montageanleitungen und Maßskizzen als PDF-Download zur Verfügung.

Assembly instructions as PDF download

All installation instructions and dimensional diagrams are available on the HAILO website for downloading as PDF files.



Unser Qualitätsanspruch.

Our quality standards.

Alle HAILO-Systeme unterliegen strengsten Qualitätsprüfungen. Eine neue Produktserie geht erst auf den Markt, wenn z.B. 100.000 Auszugszyklen unter strengen Laborbedingungen getestet wurden.

Hochwertige Auszugsschienen gewährleisten einen sicheren, ruhigen Lauf – ein Produktleben lang! Man sieht sie nicht, aber man fühlt und spürt sie bei jeder Betätigung.

HAILO Einbautechnik erfüllt in allen Belangen die hohen Anforderungen unserer anspruchsvollen Kunden. Diese Qualitätsstandards zu erfüllen, ist unser Anspruch.

All HAILO systems are subject to the strictest quality tests. A new product series is only launched on the market when, for example, 100,000 pull-out cycles have been tested under strict laboratory conditions.

High-quality slides guarantee safe, smooth running – for the life of the product! You can't see them, but you can feel and sense them every time you pull them out.

HAILO Built-In Technology meets the high demands of our discerning customers in every respect. Our aim is to meet these quality standards.



Inhalt.

Contents.

23

173

207

223

253

272



Abfallsammler und Abfalltrennsysteme.

Waste bins and waste separation systems.

Ordnungssysteme.

Organizer systems.

Funktionssysteme.

Functional systems.

Hauswirtschaftsraum.

Utility room.

Inneneimer & Zubehör

Inner bins & accessories.

Kundenspezifische Lösungen.

Customized solutions.



SWING.

Einbau-Systeme für Drehtürschränke.

Fitment Systems for hinged door cabinets.

	Seite/Page
30 cm Breite/Width	25
40 cm Breite/Width	41
45 cm Breite/Width	67
50 cm Breite/Width	89
60 cm Breite/Width	111
Diagonal-Eckspülenschrank <i>Diagonal door corner-sink-cabinets</i>	149



SLIDE.

Einbau-Systeme mit Frontanbindung.

Fitment Systems for front-mount-door cabinets.

	Seite/Page
30 cm Breite/Width	31
40 cm Breite/Width	59
45 cm Breite/Width	73
50 cm Breite/Width	95
60 cm Breite/Width	115
90 cm Breite/Width	155
15", 18", 21", 24" Breite/Width	165



INSET.

Einbau-Systeme zum Einsatz in Schubkästen.

Fitment Systems for installation into standard-drawers.

	Seite/Page
30 cm Breite/Width	37
40 cm Breite/Width	63
45 cm Breite/Width	83
50 cm Breite/Width	105
60 cm Breite/Width	127
80 cm Breite/Width	145
90 cm Breite/Width	159



Abfallsammler und Abfalltrennsysteme.

Waste bins and waste separation systems.

Schrankbreite <i>Cabinet width</i>	Seite <i>Page</i>
30 cm	25 - 39
40 cm	41 - 65
45 cm	67 - 87
50 cm	89 - 109
60 cm	111 - 139
80 cm	145 - 147
90 cm	149 - 163
15" 18" 21" 24"	165 - 171

30 cm

40 cm

45 cm

50 cm

60 cm

80 cm

90 cm

Inch



SWING

Übrigens, wussten Sie, ...

By the way, did you know ...

... dass der HAILO Tandem mit über 13 Millionen Exemplaren das meistverkaufte Einbau-Abfalltrennsystem der Welt ist?

... that the HAILO Tandem is the most sold fitted waste separation system in the world, with more than 13 million units sold?

30 CM



Für Schränke ab 300 mm Breite mit Drehtür.
For hinged door cabinets from 300 mm width.



30 CM SWING.



HAILO AS Tandem 15/15 Black Edition.



3666851

Trennung:	2-fach
Abfalleimer:	2 x 15 l, Gesamtvolumen 30 l, 1 x Behälterdeckel 15 l
Montageart:	Bodenmontage
Auszugsschienen:	Vollauszug
Farbe:	Metall- und Kunststoffteile schwarz
Produktmaße (B x T x H):	251 x 482 x 400 mm
Verpackungsmaße (B x T x H):	260 x 504 x 420 mm
Gewicht mit Verpackung:	7 kg
Kunststoffteile aus recyceltem Kunststoff	

HAILO AS Tandem 15/15 dunkelgrau.



3650101

Trennung:	2-fach
Abfalleimer:	2 x 15 l, Gesamtvolumen 30 l
Montageart:	Bodenmontage
Auszugsschienen:	Teilauszug
Farbe:	Metallteile silberfarben, Kunststoffteile dunkelgrau
Produktmaße (B x T x H):	252 x 505 x 415 mm
Verpackungsmaße (B x T x H):	270 x 518 x 440 mm
Gewicht mit Verpackung:	5 kg

HAILO AS Solo 20 manual.



3635001

Abfalleimer:	1 x 20 l
Montageart:	Bodenmontage
Auszugsschienen:	Vollauszug
Farbe:	Metall- und Kunststoffteile dunkelgrau
Produktmaße (B x T x H):	245 x 427 x 396 mm
Verpackungsmaße (B x T x H):	260 x 435 x 410 mm
Gewicht mit Verpackung:	4,3 kg

Für Schränke ab 300 mm Breite mit Drehtür.

For hinged door cabinets from 300 mm width.

Passend für Schränke
Suitable for cabinets

30 **40** **45** **50** **60** cm

Separation: 2-fold
Inner bins: 2 x 15 l, Total capacity 30 l, 1 x Lid 15 l
Type of installation: **bottom-mounted**
Slides: full extension
Colour: Metal parts black, Plastic parts black
Product dimensions (W x D x H): 251 x 482 x 400 mm
Packing dimensions (W x D x H): 260 x 504 x 420 mm
Weight incl. packing: 7 kg
 Plastic parts made from recycled plastic

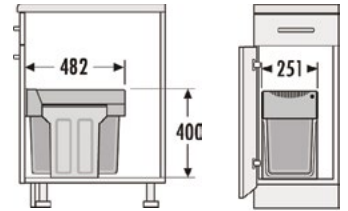

Passend für Schränke
Suitable for cabinets

30 **40** **45** **50** **60** cm

Separation: 2-fold
Inner bins: 2 x 15 l, Total capacity 30 l
Type of installation: **bottom-mounted**
Slides: single extension
Colour: Metal parts silver-coloured, Plastic parts dark-grey
Product dimensions (W x D x H): 252 x 505 x 415 mm
Packing dimensions (W x D x H): 270 x 518 x 440 mm
Weight incl. packing: 5 kg

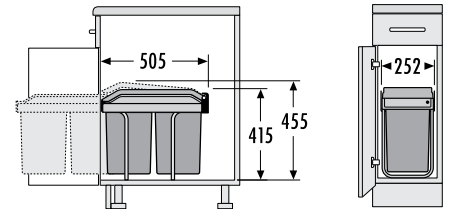

Passend für Schränke
Suitable for cabinets

30 **40** **45** **50** **60** cm

Inner bin: 1 x 20 l
Type of installation: **bottom-mounted**
Slides: full extension
Colour: Metal and plastic parts dark-grey
Product dimensions (W x D x H): 245 x 427 x 396 mm
Packing dimensions (W x D x H): 260 x 435 x 410 mm
Weight incl. packing: 4,3 kg

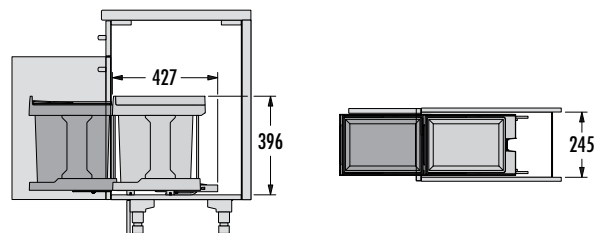

30 cm

40 cm

45 cm

50 cm

60 cm

80 cm

90 cm

Inch

30 CM SWING.



HAILO AS Pico 5.

3505001



Abfalleimer:	1 x 5 l
Montageart:	Seitenwandmontage mit Türmitnehmer
Farbe:	Metall- und Kunststoffteile weiß
Produktmaße (B x T x H):	175 x 175 x 310 mm
Verpackungsmaße (B x T x H):	185 x 185 x 310 mm
Gewicht mit Verpackung:	0,71 kg
Kann links- wie rechtsseitig montiert werden	

Für Schränke ab 300 mm Breite mit Drehtür.

For hinged door cabinets from 300 mm width.

Passend für Schränke
Suitable for cabinets

30 40 45 50 60 cm

Inner bin: 1 x 5 l
Type of installation: side-wall-mounted, with door follower
 Colour: Metal and plastic parts white
 Product dimensions (W x D x H): 175 x 175 x 310 mm
 Packing dimensions (W x D x H): 185 x 185 x 310 mm
 Weight incl. packing: 0,71 kg
 May be installed on left or on right sidewall

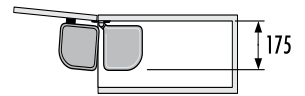
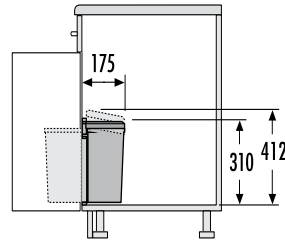

30 cm

40 cm

45 cm

50 cm

60 cm

80 cm

90 cm

Inch



Übrigens, wussten Sie, ...

By the way, did you know ...

... dass HAILO der Erfinder des Einbau-Abfalltrennsystems ist?

... that HAILO is the inventor of the fitted waste separation system?

30 CM



Für Schränke mit 300 mm Breite mit Frontauszug.

For cabinets with front-mount-door of 300 mm width.



30 CM SLIDE.

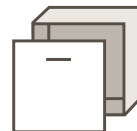

HAILO AS Cargo Synchro 300 30.



3608311

Abfalleimer:	1 x 30 l
Montageart:	Seitenwandmontage, selbstjustierend 16 - 19 mm
Auszugsschienen:	abgedeckter, gedämpfter Selbsteinzug mit synchronisiertem Überauszug
Systemtiefe:	403 mm
Deckel:	Herausfahrbarer Systemdeckel aus Metall/Kunststoff, vollflächig belegt mit rutschfester Gummimatte
Farbe:	Metall- und Kunststoffteile dunkelgrau
Produktmaße (B x T x H):	262-268 x 403 x 507 mm
Verpackungsmaße (B x T x H):	545 x 320 x 450 mm
Gewicht mit Verpackung:	9,4 kg

HAILO AS Cargo 300 15/10/D.



3610871

Abfalleimer:	1 x 15 + 1 x 10 l, Gesamtvolumen: 25 l
Montageart:	Seitenwandmontage, selbstjustierend 16 - 19 mm
Auszugsschienen:	abgedeckter, gedämpfter Selbsteinzug mit synchronisiertem Überauszug
Systemtiefe:	448 mm
Deckel:	Metallsystemdeckel + 1 x Behälterdeckel 10 l
Farbe:	Metall- und Kunststoffteile dunkelgrau
Produktmaße (B x T x H):	262-268 x 403 x 388 mm
Verpackungsmaße (B x T x H):	465 x 330 x 320 mm
Gewicht mit Verpackung:	8,5 kg

HAILO AS Euro Cargo S 300 30.



3610121

Abfalleimer:	1 x 30 l
Montageart:	Seitenwandmontage, selbstjustierend 16 - 19 mm
Auszugsschienen:	abgedeckter, gedämpfter Selbsteinzug mit synchronisiertem Überauszug
Systemtiefe:	448 mm
Deckel:	Metallsystemdeckel
Farbe:	Metallteile silberfarben, Kunststoffteile hellgrau
Produktmaße (B x T x H):	262-268 x 403 x 446 mm
Verpackungsmaße (B x T x H):	510 x 345 x 415 mm
Gewicht mit Verpackung:	8,45 kg

Für Schränke mit 300 mm Breite mit Frontauszug.

For cabinets with front-mount-door of 300 mm width.

30 cm

Inner bin: 1 x 30 l
Type of installation: side-wall-mounted, self-adjusting to 16 - 19 mm side walls
Slides: covered, dampened slides with self-closing device with fully synchronized over-travel
System-depth: 403 mm
Lid: Pullout metal/ plastic system lid, with anti-slip rubber mat
Colour: Metal and plastic parts dark grey
Product dimensions (W x D x H): 262-268 x 403 x 507 mm
Packing dimensions (W x D x H): 545 x 320 x 450 mm
Weight incl. packing: 9,4 kg

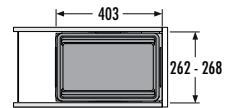
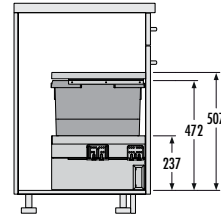

40 cm

45 cm

50 cm

Inner bins: 1 x 15 + 1 x 10 l, Total capacity: 25 l
Type of installation: side-wall-mounted, self-adjusting to 16 - 19 mm side walls
Slides: covered, dampened slides with self-closing device, with fully synchronized over-travel
System-depth: 448 mm
Lid: Metal system lid + 1x lid 10 l
Colour: Metal and plastic parts dark grey
Product dimensions (W x D x H): 262-268 x 403 x 388 mm
Packing dimensions (W x D x H): 465 x 330 x 320 mm
Weight incl. packing: 8,5 kg

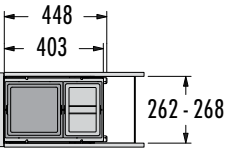
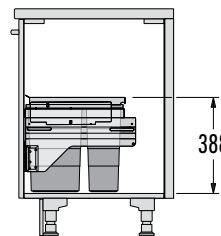

60 cm

80 cm

90 cm

Inch

Inner bin: 1 x 30 l
Type of installation: side-wall-mounted, self-adjusting to 16 - 19 mm side walls
Slides: covered, dampened slides with self-closing device, with fully synchronized over-travel
System-depth: 448 mm
Lid: Sheet metal system Lid
Colour: Metal parts silver-coloured, plastic parts light grey
Product dimensions (W x D x H): 262-268 x 403 x 446 mm
Packing dimensions (W x D x H): 510 x 345 x 415 mm
Weight incl. packing: 8,45 kg

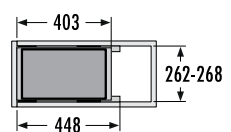
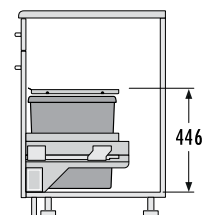

33

30 CM SLIDE.

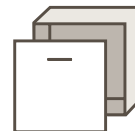

HAILO Kick and Go.

3691301



Fußhebel

"Kick and go" für Frontauszüge
und untere Schubkästen

siehe Seite 212

HAILO Libero 3.0.

3697301



Elektronischer Türöffner

HAILO Libero – Hands Free Opener

Der Laser-Sensoröffner von HAILO für ein automatisches,
komfortables Öffnen aller Abfalltrennsysteme mit
Frontanbindung und aller Auszugssysteme.

Einfache Bedienung durch Fußsensor und / oder
Sprachsteuerung.

Ausführliche Beschreibung Seite 210

Für Schränke mit Frontauszug.

For cabinets with front-mount-door.

Foot Pedal

"Kick and go" for Front mounted door and lower drawer

More information: page 212



3691301



4 007126 369123

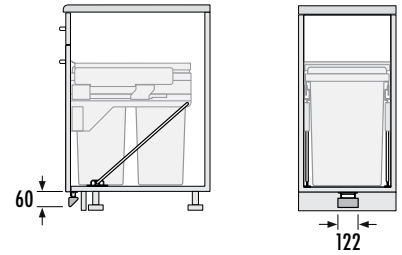

Electronic Door Opener

HAILO „Liberò“ – Hands Free Opener

HAILO's electronic sensor-opener Libero 3.0 for front-mount-doors and drawers offers an automatic, comfortable hands-free opening of all waste-recycling-systems with attached door-panel, and of any common, also damped, drawer-mounted systems. Easy operation by laser-sensor and / or optionally voice activated.

More information: page 210



3697301



4 007126 301000

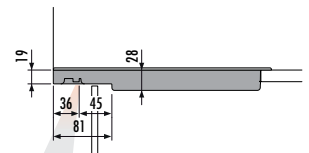
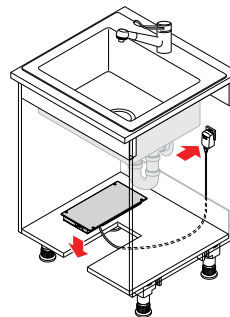

30 cm

40 cm

45 cm

50 cm

60 cm

80 cm

90 cm

Inch



**T
E
S
N
I**

Übrigens, wussten Sie, ...

By the way, did you know ...

... dass HAILO Einbautechnik viele Standards durch Innovationen (Rondo, Mono, Tandem, Cargo etc.) gesetzt hat?

... that HAILO Built-In Technology has set many standards through innovation (Rondo, Mono, Tandem, Cargo, etc.)?

30 CM



Einsatz für Schubkästen mit 300 mm Breite.
For common drawer cabinets of 300 mm width.



30 CM INSET.

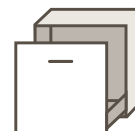

HAILO AS Euro Cargo 300 38/7 dunkelgrau.



3669101

Trennung:	2-fach
Abfalleimer:	1 x 38 l, 1 x 7 l, Gesamtvolumen 45 l
Montageart:	Schubkastenmontage
Schubkasten Nenntiefe:	≥ 500 mm
Deckel:	Kunststoffsystendeckel
Farbe:	Metall- und Kunststoffteile dunkelgrau
Produktmaße (B x T x H):	259 x 484 x 550 mm
Verpackungsmaße (B x T x H):	490 x 290 x 605 mm
Gewicht mit Verpackung:	4 kg

HAILO AS Tandem 15/15 dunkelgrau.

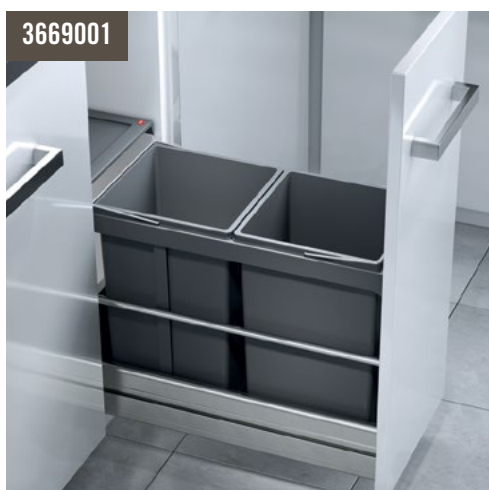

3669001

Trennung:	2-fach
Abfalleimer:	2 x 15 l, Gesamtvolumen 30 l
Montageart:	Schubkastenmontage
Schubkasten Nenntiefe:	≥ 500 mm
Deckel:	Kunststoffsystendeckel
Farbe:	Metall- und Kunststoffteile dunkelgrau
Produktmaße (B x T x H):	259 x 484 x 375 mm
Verpackungsmaße (B x T x H):	260 x 504 x 420 mm
Gewicht mit Verpackung:	3,1 kg

Einsatz für Schubkästen mit 300 mm Breite.

For common drawer cabinets of 300 mm width.

Separation:	2-fold
Inner bins:	1 x 38 l, 1 x 7 l, Total capacity 45 l
Type of installation:	inside available drawer
Nominal drawer-depth:	≥ 500 mm
Lid:	Plastic system lid
Colour:	Metal and plastic parts dark grey
Product dimensions (W x D x H):	259 x 484 x 550 mm
Packing dimensions (W x D x H):	490 x 290 x 605 mm
Weight incl. packing:	4 kg



3669101

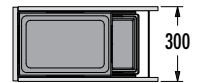
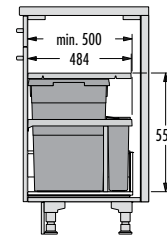

30 cm

40 cm

45 cm

50 cm

60 cm

80 cm

90 cm

Inch

Separation:	2-fold
Inner bins:	2 x 15 l, Total capacity 30 l
Type of installation:	inside available drawer
Nominal drawer-depth:	≥ 500 mm
Lid:	Plastic system lid
Colour:	Metal and plastic parts dark grey
Product dimensions (W x D x H):	259 x 484 x 375 mm
Packing dimensions (W x D x H):	260 x 504 x 420 mm
Weight incl. packing:	3,1 kg



3669001

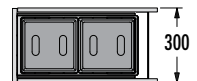
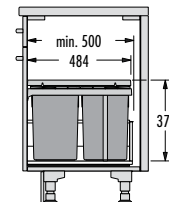



SWING

Übrigens, wussten Sie, ...

By the way, did you know ...

... dass HAILO bereits 1953 den ersten Einbau-Abfallsammler für Küchen auf den Markt brachte?

... that HAILO already introduced the first built-in waste bin in 1953?

40 CM



Für Schränke ab 400 mm Breite mit Drehtür.
For hinged door cabinets from 400 mm width.



40 CM SWING.



HAILO AS Tandem 13/13.

3666901



NEW

Trennung:	2-fach
Abfalleimer:	2 x 13 l, Gesamtvolumen 26 l
Montageart:	Bodenmontage
Auszugsschienen:	Vollauszug
Farbe:	Metall- und Kunststoffteile dunkelgrau
Produktmaße (B x T x H):	263 x 437 x 401 mm
Verpackungsmaße (B x T x H):	457 x 283 x 420 mm
Schrantiefe min. (nutzbar):	437 mm
Gewicht inkl. Verpackung:	5,98 kg

HAILO AS Tandem 28.

3666911



NEW

Abfalleimer:	1 x 28 l
Montageart:	Bodenmontage
Auszugsschienen:	Vollauszug
Farbe:	Metall- und Kunststoffteile dunkelgrau
Produktmaße (B x T x H):	263 x 437 x 401 mm
Verpackungsmaße (B x T x H):	457 x 283 x 420 mm
Schrantiefe min. (nutzbar):	437 mm
Gewicht inkl. Verpackung:	5,71 kg

HAILO AS Tandem 8/8/8.

3666921



NEW

Trennung:	3-fach
Abfalleimer:	3 x 8 l, Gesamtvolumen 24 l
Montageart:	Bodenmontage
Auszugsschienen:	Vollauszug
Farbe:	Metall- und Kunststoffteile dunkelgrau
Produktmaße (B x T x H):	263 x 437 x 401 mm
Verpackungsmaße (B x T x H):	457 x 283 x 420 mm
Schrantiefe min. (nutzbar):	437 mm
Gewicht inkl. Verpackung:	6,22 kg

Für Schränke ab 400 mm Breite mit Drehtür.

For hinged door cabinets from 400 mm width.

Passend für Schränke
Suitable for cabinets

40 45 50 60 cm

Separation: 2-fold
 Inner bins: 2 x 13 l, Total capacity 26 l
Type of installation: **bottom-mounted**
 Slides: full extension
 Colour: Metal parts black, Plastic parts dark grey
 Product dimensions (W x D x H): 263 x 437 x 401 mm
 Packing dimensions (W x D x H): 457 x 283 x 420 mm
 available Cabinet-depth min.: 437 mm
 Weight incl. packing: 5,98 kg

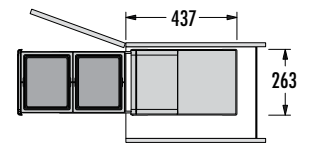
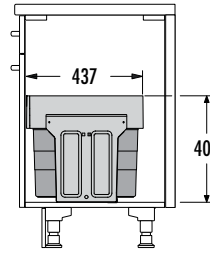

Passend für Schränke
Suitable for cabinets

40 45 50 60 cm

Inner bins: 1 x 28
Type of installation: **bottom-mounted**
 Slides: full extension
 Colour: Metal parts black, Plastic parts dark grey
 Product dimensions (W x D x H): 263 x 437 x 401 mm
 Packing dimensions (W x D x H): 457 x 283 x 420 mm
 available Cabinet-depth min.: 437 mm
 Weight incl. packing: 5,71 kg

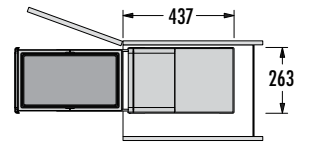
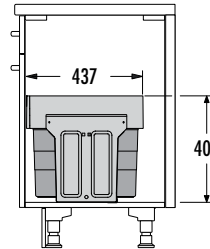

Passend für Schränke
Suitable for cabinets

40 45 50 60 cm

Separation: 3-fold
 Inner bins: 3 x 8 l, Total capacity 24 l
Type of installation: **bottom-mounted**
 Slides: full extension
 Colour: Metal parts black, Plastic parts dark grey
 Product dimensions (W x D x H): 263 x 437 x 401 mm
 Packing dimensions (W x D x H): 457 x 283 x 420 mm
 available Cabinet-depth min.: 437 mm
 Weight incl. packing: 6,22 kg

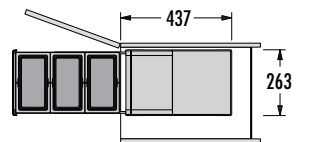
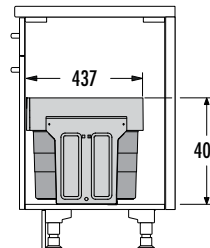

30 cm

40 cm

45 cm

50 cm

60 cm

80 cm

90 cm

Inch

40 CM SWING.



HAILO AS Solo 20 automatic.

3636001



Abfalleimer:	1 x 20 l
Montageart:	Bodenmontage
Auszugsschienen:	Vollauszug mit Ausfahrautomatik
Farbe:	Metall- und Kunststoffteile dunkelgrau
Produktmaße (B x T x H):	245 x 427 x 396 mm
Verpackungsmaße (B x T x H):	260 x 435 x 410 mm
Gewicht mit Verpackung:	4,3 kg

HAILO Carry2.

3950551



Praktischer Tragekorb für Spülmittel und mehr – ideale Ergänzung zum Abfalltrennsystem im Spülenschrank.

Farbe:	Kunststoffteile dunkelgrau
Produktmaße (B x T x H):	403 x 140 x 340 mm

Mobil und flexibel – Tragekörbe stapelbar (für Einlagerung und Transport)
Stabiler Kunststoff – gute Haptik am Tragegriff
Putzmittel und Co. gut verstaut und schnell griffbereit
Geeignet zur Kombination mit Abfalltrennsystem, in Schränken ab 600 mm Breite



Für Schränke ab 400 mm Breite mit Drehtür.

For hinged door cabinets from 400 mm width.

Passend für Schränke
Suitable for cabinets

40 45 50 60 cm

Inner bin: 1 x 20 l
Type of installation: bottom-mounted
 Slides: full extension with automatic door-follower
 Colour: Metal and plastic parts dark grey
 Product dimensions (W x D x H): 245 x 427 x 396 mm
 Packing dimensions (W x D x H): 260 x 435 x 410 mm
 Weight incl. packing: 4,3 kg

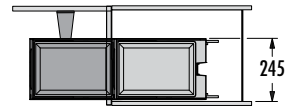
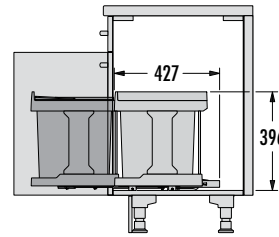

Passend für Schränke
Suitable for cabinets

40 45 50 60 cm

Practical carrying basket for detergents and more –
ideal complement to the waste separation system in the sink cabinet.

Colour: Plastic parts dark grey
 Product dimensions (W x D x H): 403 x 140 x 340 mm

Mobile and flexible – Carrying baskets stackable (for storage and transport)
 Sturdy plastic – good haptics at the carrying handle
 Cleaning agents and co. well stored and quickly at hand
 Suitable for combination with waste separation system,
 in cabinets as of 600 mm width



30 cm

40 cm

45 cm

50 cm

60 cm

80 cm

90 cm

Inch

40 CM SWING.



HAILO AS Mono 12 weiß.

3512001



Abfalleimer:	1 x 12 l
Montageart:	Seitenwandmontage mit Türmitnehmer
Deckel:	Federloser, automatischer Dreh-Kipp-Deckel
Farbe:	Metall- und Kunststoffteile weiß
Produktmaße (B x T x H):	290 x 304 x 295 mm
Verpackungsmaße (B x T x H):	293 x 298 x 298 mm
Gewicht mit Verpackung:	1,85 kg
Kann links- wie rechtsseitig montiert werden	

HAILO AS Mono 12 Edelstahl/schwarz.

3512031



Abfalleimer:	1 x 12 l
Montageart:	Seitenwandmontage mit Türmitnehmer
Deckel:	Federloser, automatischer Dreh-Kipp-Deckel
Farbe:	Metallteile Edelstahl, Kunststoffteile schwarz
Produktmaße (B x T x H):	290 x 304 x 295 mm
Verpackungsmaße (B x T x H):	293 x 298 x 298 mm
Gewicht mit Verpackung:	1,85 kg
Kann links- wie rechtsseitig montiert werden	

HAILO AS Mono 15 weiß.

3515001



Abfalleimer:	1 x 15 l
Montageart:	Seitenwandmontage mit Türmitnehmer
Deckel:	Federloser, automatischer Dreh-Kipp-Deckel
Farbe:	Metall- und Kunststoffteile weiß
Produktmaße (B x T x H):	290 x 304 x 365 mm
Verpackungsmaße (B x T x H):	298 x 298 x 363 mm
Gewicht mit Verpackung:	2,05 kg
Kann links- wie rechtsseitig montiert werden	

Für Schränke ab 400 mm Breite mit Drehtür.

For hinged door cabinets from 400 mm width.

Passend für Schränke
Suitable for cabinets

40 45 50 60 cm

Inner bin: 1 x 12 l
Type of installation: side-wall-mounted, with door follower
Lid: Springless turn and tilt lid
Colour: Metal and plastic parts white
Product dimensions (W x D x H): 290 x 304 x 295 mm
Packing dimensions (W x D x H): 293 x 298 x 298 mm
Weight incl. packing: 1,85 kg
 May be installed on left or on right sidewall

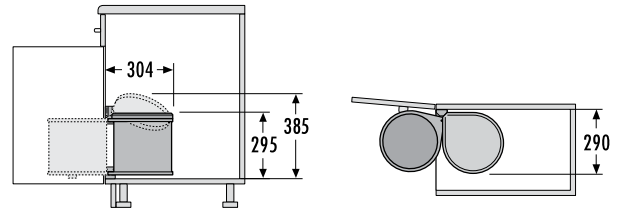

Passend für Schränke
Suitable for cabinets

40 45 50 60 cm

Inner bin: 1 x 12 l
Type of installation: side-wall-mounted, with door follower
Lid: Springless turn and tilt lid
Colour: Metal parts stainless steel, Plastic parts black
Product dimensions (W x D x H): 290 x 304 x 295 mm
Packing dimensions (W x D x H): 293 x 298 x 298 mm
Weight incl. packing: 1,85 kg
 May be installed on left or on right sidewall

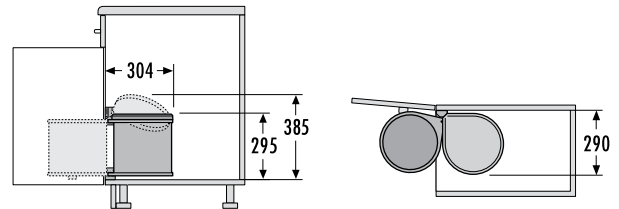

Passend für Schränke
Suitable for cabinets

40 45 50 60 cm

Inner bin: 1 x 15 l
Type of installation: side-wall-mounted, with door follower
Lid: Springless turn and tilt lid
Colour: Metal and plastic parts white
Product dimensions (W x D x H): 290 x 304 x 365 mm
Packing dimensions (W x D x H): 298 x 298 x 363 mm
Weight incl. packing: 2,05 kg
 May be installed on left or on right sidewall

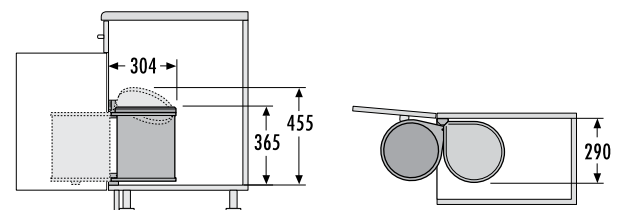

30 cm

40 cm

45 cm

50 cm

60 cm

80 cm

90 cm

Inch

40 CM SWING.



HAILO AS Mono 15 dunkelgrau/schwarz.

3515071



Abfalleimer:	1 x 15 l
Montageart:	Seitenwandmontage mit Türmitnehmer
Deckel:	Federloser, automatischer Dreh-Kipp-Deckel
Farbe:	Metallteile dunkelgrau, Kunststoffteile schwarz
Produktmaße (B x T x H):	290 x 304 x 365 mm
Verpackungsmaße (B x T x H):	298 x 298 x 363 mm
Gewicht mit Verpackung:	2,05 kg
Kann links- wie rechtsseitig montiert werden	

HAILO AS Mono 15 Edelstahl/weiß.

3515011



Abfalleimer:	1 x 15 l
Montageart:	Seitenwandmontage mit Türmitnehmer
Deckel:	Federloser, automatischer Dreh-Kipp-Deckel
Farbe:	Metallteile Edelstahl, Kunststoffteile weiß
Produktmaße (B x T x H):	290 x 304 x 365 mm
Verpackungsmaße (B x T x H):	298 x 298 x 363 mm
Gewicht mit Verpackung:	2,05 kg
Kann links- wie rechtsseitig montiert werden	

HAILO AS Mono 15 Edelstahl/schwarz.

3515031



Abfalleimer:	1 x 15 l
Montageart:	Seitenwandmontage mit Türmitnehmer
Deckel:	Federloser, automatischer Dreh-Kipp-Deckel
Farbe:	Metallteile Edelstahl, Kunststoffteile schwarz
Produktmaße (B x T x H):	290 x 304 x 365 mm
Verpackungsmaße (B x T x H):	298 x 298 x 363 mm
Gewicht mit Verpackung:	2,05 kg
Kann links- wie rechtsseitig montiert werden	

Für Schränke ab 400 mm Breite mit Drehtür.

For hinged door cabinets from 400 mm width.

Passend für Schränke
Suitable for cabinets

40 45 50 60 cm

Inner bin: 1 x 15 l
Type of installation: side-wall-mounted, with door follower
Lid: Springless turn and tilt lid
Colour: Metal parts dark-grey, Plastic parts black
Product dimensions (W x D x H): 290 x 304 x 365 mm
Packing dimensions (W x D x H): 298 x 298 x 363 mm
Weight incl. packing: 2,05 kg
 May be installed on left or on right sidewall

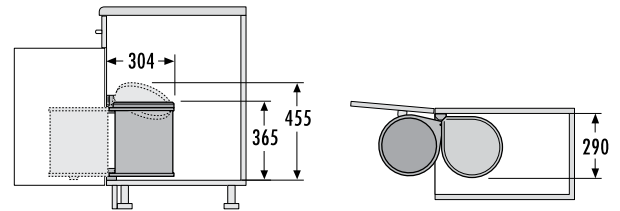

Passend für Schränke
Suitable for cabinets

40 45 50 60 cm

Inner bin: 1 x 15 l
Type of installation: side-wall-mounted, with door follower
Lid: Springless turn and tilt lid
Colour: Metal parts stainless steel, Plastic parts white
Product dimensions (W x D x H): 290 x 304 x 365 mm
Packing dimensions (W x D x H): 298 x 298 x 363 mm
Weight incl. packing: 2,05 kg
 May be installed on left or on right sidewall

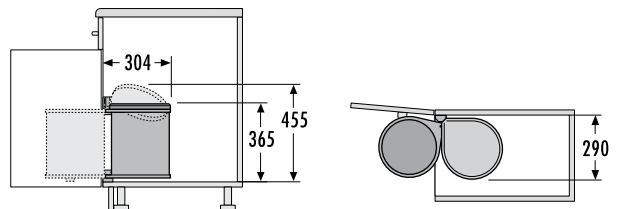

Passend für Schränke
Suitable for cabinets

40 45 50 60 cm

Inner bin: 1 x 15 l
Type of installation: side-wall-mounted, with door follower
Lid: Springless turn and tilt lid
Colour: Metal parts stainless steel, Plastic parts black
Product dimensions (W x D x H): 290 x 304 x 365 mm
Packing dimensions (W x D x H): 298 x 298 x 363 mm
Weight incl. packing: 2,05 kg
 May be installed on left or on right sidewall

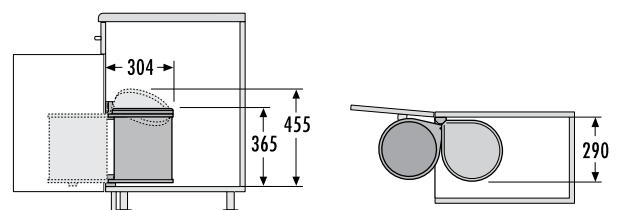

30 cm

40 cm

45 cm

50 cm

60 cm

80 cm

90 cm

Inch

40 CM SWING.



HAILO AS Mono 20 Edelstahl/schwarz.

3520001



NEW

Abfalleimer:	1 x 20 l
Montageart:	Seitenwandmontage mit Türmitnehmer
Deckel:	Federloser, automatischer Dreh-Kipp-Deckel
Farbe:	Metallteile Edelstahl, Kunststoffteile schwarz
Produktmaße (B x T x H):	290 x 304 x 456 mm
Verpackungsmaße (B x T x H):	461 x 295 x 295 mm
Gewicht mit Verpackung:	3,5 kg
Schranktiefe min. (nutzbar):	305 mm
Kann links- wie rechtsseitig montiert werden	

HAILO AS Easy Cargo 42.

3668401



Abfalleimer:	1 x 42 l
Montageart:	Bodenmontage
Auszugsschienen:	Vollauszug
Farbe:	Metallteile silberfarben, Kunststoffteile hellgrau
Produktmaße (B x T x H):	320 x 466 x 542 mm
Verpackungsmaße (B x T x H):	345 x 510 x 560 mm
Gewicht mit Verpackung:	8,1 kg
Praktische Ablagemulde im Deckel integriert	

HAILO AS Easy Cargo 42.

3668421



Abfalleimer:	1 x 42 l
Montageart:	Bodenmontage
Auszugsschienen:	Vollauszug
Farbe:	Metallteile silberfarben, Kunststoffteile hellgrau
Produktmaße (B x T x H):	320 x 466 x 542 mm
Verpackungsmaße (B x T x H):	345 x 510 x 560 mm
Gewicht mit Verpackung:	8,4 kg
Beutelhalter zum Fixieren von Müllbeuteln wie zB. „Gelber Sack“	
Praktische Ablagemulde im Deckel integriert	

Für Schränke ab 400 mm Breite mit Drehtür.

For hinged door cabinets from 400 mm width.

Passend für Schränke
Suitable for cabinets

40 45 50 60 cm

Inner bin: 1 x 20 l
Type of installation: side-wall-mounted, with door follower
Lid: Springless turn and tilt lid
Colour: Metal parts stainless steel, Plastic parts black
Product dimensions (W x D x H): 290 x 304 x 456 mm
Packing dimensions (W x D x H): 461 x 295 x 295 mm
Weight incl. packing: 3,5 kg

May be installed on left or on right sidewall

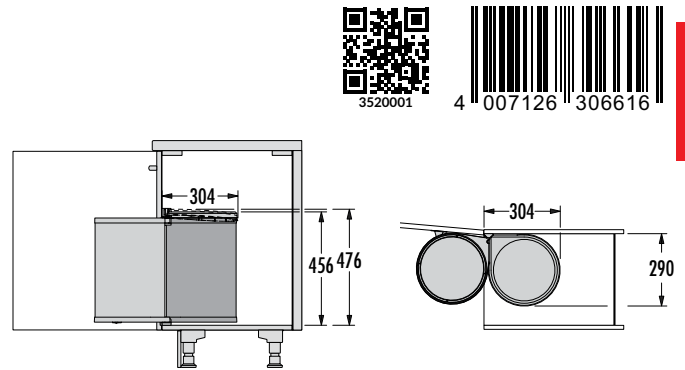

Passend für Schränke
Suitable for cabinets

40 45 50 60 cm

Inner bin: 1 x 42 l
Type of installation: bottom-mounted
Slides: full extension
Colour: Metal parts silver-coloured, Plastic parts light grey
Product dimensions (W x D x H): 320 x 466 x 542 mm
Packing dimensions (W x D x H): 345 x 510 x 560 mm
Weight incl. packing: 8,1 kg
Practical storage area integrated in the lid

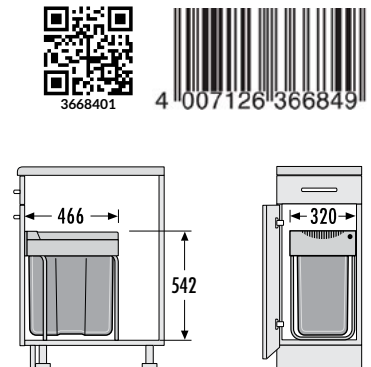

Passend für Schränke
Suitable for cabinets

40 45 50 60 cm

Inner bin: 1 x 42 l
Type of installation: bottom-mounted
Slides: full extension
Colour: Metal parts silver-coloured, Plastic parts light grey
Product dimensions (W x D x H): 320 x 466 x 542 mm
Packing dimensions (W x D x H): 345 x 510 x 560 mm
Weight incl. packing: 8,4 kg
Bagholder to fix trash bag
Practical storage area integrated in the lid

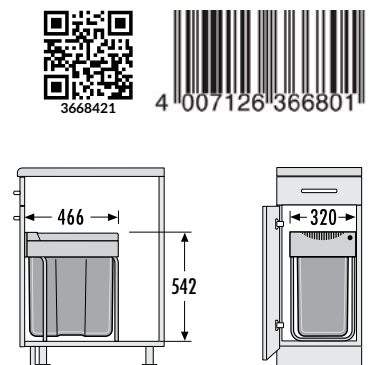

30 cm

40 cm

45 cm

50 cm

60 cm

80 cm

90 cm

Inch

40 CM SWING.



HAILO AS Raumspar Tandem 18/18.

3641121



Trennung:	2-fach
Abfalleimer:	2 x 18 l, Gesamtvolumen 36 l
Montageart:	Bodenmontage
Auszugsschienen:	Vollauszug
Farbe:	Metallteile silberfarben, Kunststoffteile hellgrau
Produktmaße (B x T x H):	346 x 475 x 336 mm
Verpackungsmaße (B x T x H):	360 x 490 x 370 mm
Gewicht mit Verpackung:	5 kg

HAILO AS Raumspar Tandem 18/18 dunkelgrau.

3641521



Trennung:	2-fach
Abfalleimer:	2 x 18 l, Gesamtvolumen 36 l
Montageart:	Bodenmontage
Auszugsschienen:	Vollauszug
Farbe:	Metallteile silberfarben, Kunststoffteile dunkelgrau
Produktmaße (B x T x H):	346 x 475 x 336 mm
Verpackungsmaße (B x T x H):	360 x 490 x 370 mm
Gewicht mit Verpackung:	5 kg

HAILO AS Raumspar Tandem 18/8,5/8,5/D.

3642131



Trennung:	3-fach
Abfalleimer:	1 x 18 l, 2 x 8,5 l, Gesamtvolumen 35 l, 1 x Behälterdeckel 8,5 l
Montageart:	Bodenmontage
Auszugsschienen:	Vollauszug
Farbe:	Metallteile silberfarben, Kunststoffteile hellgrau
Produktmaße (B x T x H):	346 x 475 x 336 mm
Verpackungsmaße (B x T x H):	360 x 490 x 370 mm
Gewicht mit Verpackung:	6,0 kg

Für Schränke ab 400 mm Breite mit Drehtür.

For hinged door cabinets from 400 mm width.

Passend für Schränke
Suitable for cabinets

40 45 50 60 cm

Separation: 2-fold
 Inner bins: 2 x 18 l, Total capacity 36 l
Type of installation: **bottom-mounted**
 Slides: full extension
 Colour: Metal parts silver-coloured, Plastic parts light grey
 Product dimensions (W x D x H): 346 x 475 x 336 mm
 Packing dimensions (W x D x H): 360 x 490 x 370 mm
 Weight incl. packing: 5 kg

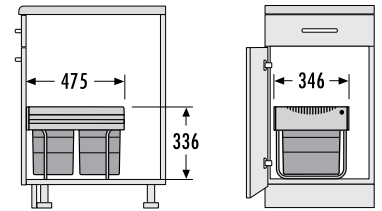

30 cm

40 cm

45 cm

50 cm

60 cm

Passend für Schränke
Suitable for cabinets

40 45 50 60 cm

Separation: 2-fold
 Inner bins: 2 x 18 l, Total capacity 36 l
Type of installation: **bottom-mounted**
 Slides: full extension
 Colour: Metal parts silver-coloured, Plastic parts dark grey
 Product dimensions (W x D x H): 346 x 475 x 336 mm
 Packing dimensions (W x D x H): 360 x 490 x 370 mm
 Weight incl. packing: 5 kg

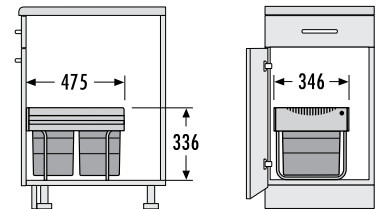

80 cm

90 cm

Inch

Passend für Schränke
Suitable for cabinets

40 45 50 60 cm

Separation: 3-fold
 Inner bins: 1 x 18 l, 2 x 8.5 l, Total capacity 35 l,
 1 x Lid 8.5 l
Type of installation: **bottom-mounted**
 Slides: full extension
 Colour: Metal parts silver-coloured, Plastic parts light grey
 Product dimensions (W x D x H): 346 x 475 x 336 mm
 Packing dimensions (W x D x H): 360 x 490 x 370 mm
 Weight incl. packing: 6,0 kg

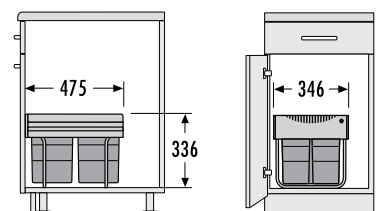

40 CM SWING.



HAILO AS Raumspar Tandem 18/8,5/8,5/D dunkelgrau.



3642531

Trennung:	3-fach
Abfalleimer:	1 x 18 l, 2 x 8,5 l, Gesamtvolumen 35 l, 1 x Behälterdeckel 8,5 l
Montageart:	Bodenmontage
Auszugsschienen:	Vollauszug
Farbe:	Metallteile silberfarben, Kunststoffteile dunkelgrau
Produktmaße (B x T x H):	346 x 475 x 336 mm
Verpackungsmaße (B x T x H):	360 x 490 x 370 mm
Gewicht mit Verpackung:	6,0 kg

NEW

HAILO AS Raumspar Tandem 18/8,5/8,5/D schwarz.



3642731

Trennung:	3-fach
Abfalleimer:	1 x 18 l, 2 x 8,5 l, Gesamtvolumen 35 l, 1 x Behälterdeckel 8,5 l
Montageart:	Bodenmontage
Auszugsschienen:	Vollauszug
Farbe:	Metallteile silberfarben, Kunststoffteile schwarz
Produktmaße (B x T x H):	346 x 475 x 336 mm
Verpackungsmaße (B x T x H):	360 x 490 x 370 mm
Gewicht mit Verpackung:	6,0 kg
	Kunststoffteile aus recyceltem Kunststoff

NEW

HAILO AS Raumspar Tandem 8,5/8,5/8,5/8,5/D.



3643141

Trennung:	4-fach
Abfalleimer:	4 x 8,5 l, Gesamtvolumen 34 l, 1 x Behälterdeckel 8,5 l
Montageart:	Bodenmontage
Auszugsschienen:	Vollauszug
Farbe:	Metallteile silberfarben, Kunststoffteile hellgrau
Produktmaße (B x T x H):	346 x 475 x 336 mm
Verpackungsmaße (B x T x H):	360 x 490 x 370 mm
Gewicht mit Verpackung:	6,3 kg



Für Schränke ab 400 mm Breite mit Drehtür.

For hinged door cabinets from 400 mm width.

Passend für Schränke
Suitable for cabinets

40 45 50 60 cm

Separation: 3-fold
Inner bins: 1 x 18 l, 2 x 8.5 l, Total capacity 35 l,
1 x Lid 8.5 l

Type of installation: bottom-mounted
Slides: full extension
Colour: Metal parts silver-coloured, Plastic parts dark grey
Product dimensions (W x D x H): 346 x 475 x 336 mm
Packing dimensions (W x D x H): 360 x 490 x 370 mm
Weight incl. packing: 6,0 kg

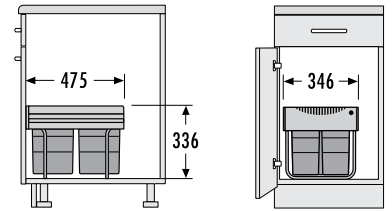

30 cm

40 cm

45 cm

50 cm

Passend für Schränke
Suitable for cabinets

40 45 50 60 cm

Separation: 3-fold
Inner bins: 1 x 18 l, 2 x 8.5 l, Total capacity 35 l,
1 x Lid 8.5 l

Type of installation: bottom-mounted
Slides: full extension
Colour: Metal parts silver-coloured, plastic parts black
Product dimensions (W x D x H): 346 x 475 x 336 mm
Packing dimensions (W x D x H): 360 x 490 x 370 mm
Weight incl. packing: 6,0 kg
Plastic parts made from recycled plastic

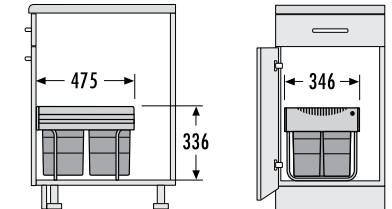

60 cm

80 cm

90 cm

Inch

Passend für Schränke
Suitable for cabinets

40 45 50 60 cm

Separation: 4-fold
Inner bins: 4 x 8.5 l, Total capacity 34 l,
1 x Lid 8.5 l

Type of installation: bottom-mounted
Slides: full extension
Colour: Metal parts silver-coloured, Plastic parts light grey
Product dimensions (W x D x H): 346 x 475 x 336 mm
Packing dimensions (W x D x H): 360 x 490 x 370 mm
Weight incl. packing: 6,3 kg

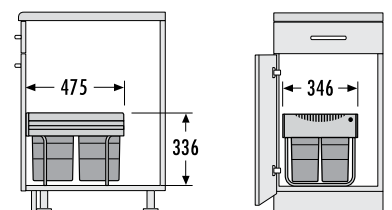

40 CM SWING.



HAILO AS Raumspar Tandem 18/18.

3640001



Trennung:	2-fach
Abfalleimer:	2 x 18 l, Gesamtvolumen 36 l
Montageart:	Bodenmontage
Auszugsschienen:	Teilauszug
Farbe:	Metallteile silberfarben, Kunststoffteile grau/schwarz
Produktmaße (B x T x H):	346 x 470 x 320 mm
Verpackungsmaße (B x T x H):	360 x 490 x 360 mm
Gewicht mit Verpackung:	4,8 kg

HAILO AS Raumspar Tandem Comfort 20/20/KS.

3641221



Trennung:	2-fach
Abfalleimer:	2 x 20 l, Gesamtvolumen 40 l
Montageart:	Bodenmontage
Auszugsschienen:	Vollauszug
Farbe:	Metallteile silberfarben, Kunststoffteile hellgrau
Produktmaße (B x T x H):	346 x 475 x 392 mm
Verpackungsmaße (B x T x H):	360 x 490 x 410 mm
Gewicht mit Verpackung:	6 kg
Mit integriertem Kehr-Set	

HAILO AS Raumspar Tandem Comfort 20/10/10/D/KS.

3642231



Trennung:	3-fach
Abfalleimer:	1 x 20 l, 2 x 10 l, Gesamtvolumen 40 l, 1 x Behälterdeckel 10 l
Montageart:	Bodenmontage
Auszugsschienen:	Vollauszug
Farbe:	Metallteile silberfarben, Kunststoffteile hellgrau
Produktmaße (B x T x H):	346 x 475 x 392 mm
Verpackungsmaße (B x T x H):	360 x 490 x 410 mm
Gewicht mit Verpackung:	7 kg
Mit integriertem Kehr-Set	

Für Schränke ab 400 mm Breite mit Drehtür.

For hinged door cabinets from 400 mm width.

Passend für Schränke
Suitable for cabinets

40 45 50 60 cm

Separation: 2-fold
 Inner bins: 2 x 18 l, Total capacity 36 l
Type of installation: **bottom-mounted**
 Slides: single extension
 Colour: Metal parts silver-coloured, Plastic parts grey/black
 Product dimensions (W x D x H): 346 x 470 x 320 mm
 Packing dimensions (W x D x H): 360 x 490 x 360 mm
 Weight incl. packing: 4,8 kg

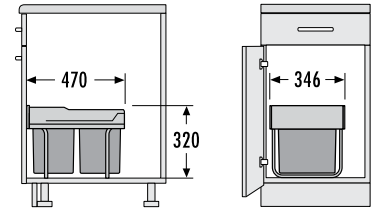

Passend für Schränke
Suitable for cabinets

40 45 50 60 cm

Separation: 2-fold
 Inner bins: 2 x 20 l, Total capacity 40 l
Type of installation: **bottom-mounted**
 Slides: full extension
 Colour: Metal parts silver-coloured, Plastic parts light grey
 Product dimensions (W x D x H): 346 x 475 x 392 mm
 Packing dimensions (W x D x H): 360 x 490 x 410 mm
 Weight incl. packing: 6 kg
 Equipped with a dust-pan and brush

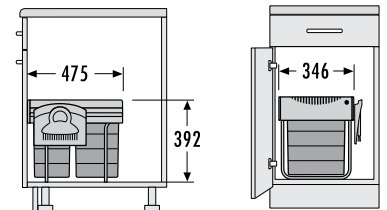

Passend für Schränke
Suitable for cabinets

40 45 50 60 cm

Separation: 3-fold
 Inner bins: 1 x 20 l, 2 x 10 l, Total capacity 40 l,
 1 x Lid 10 l
Type of installation: **bottom-mounted**
 Slides: full extension
 Colour: Metal parts silver-coloured, Plastic parts light grey
 Product dimensions (W x D x H): 346 x 475 x 392 mm
 Packing dimensions (W x D x H): 360 x 490 x 410 mm
 Weight incl. packing: 7 kg
 Equipped with a dust-pan and brush

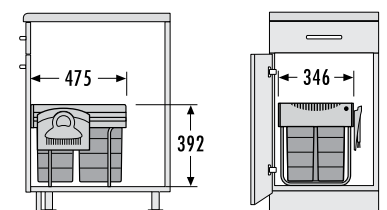

30 cm

40 cm

45 cm

50 cm

60 cm

80 cm

90 cm

Inch



Übrigens, wussten Sie, ...

By the way, did you know ...

... dass HAILO bereits 1993 ein Abfalltrennsystem mit Frontanbindung und Auszugsschienen auf den Markt brachte und somit als Pionier dieser Systeme gilt?

... that HAILO as a pioneer launched a waste separation system with front attachment and drawer slides in 1993?

40 CM



Für Schränke mit 400 mm Breite mit Frontauszug.

For cabinets with front-mount-door of 400 mm width.



40 CM SLIDE.

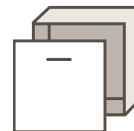

HAILO AS Euro Cargo 400 38/7.

3619421



Trennung:	2-fach
Abfalleimer:	1 x 38 l, 1 x 7 l, Gesamtvolumen 45 l
Montageart:	Seitenwandmontage, selbstjustierend 16 - 19 mm
Auszugsschienen:	abgedeckter, gedämpfter Selbsteinzug mit synchronisiertem Überauszug
Systemtiefe:	528 mm
Deckel:	Metallsystemdeckel
Farbe:	Metallteile silberfarben, Kunststoffteile hellgrau
Produktmaße (B x T x H):	362-368 x 528 x 545 mm
Verpackungsmaße (B x T x H):	490 x 320 x 620 mm
Gewicht mit Verpackung:	13,6 kg

HAILO AS Bottom Mount 400 24/D/24/D.

3616411



Trennung:	2-fach
Abfalleimer:	2 x 24 l, Gesamtvolumen 48 l, 2 Behälterdeckel 24 l
Montageart:	Bodenmontage
Auszugsschienen:	gedämpfter Selbsteinzug
Systemtiefe:	530 mm
Farbe:	Metallteile silberfarben, Kunststoffteile hellgrau
Produktmaße (B x T x H):	350 x 530 x 385 mm
Verpackungsmaße (B x T x H):	365 x 355 x 585 mm
Gewicht mit Verpackung:	9,9 kg

HAILO AS Bottom Mount 400 29/D/29/D.

3616401



Trennung:	2-fach
Abfalleimer:	2 x 29 l, Gesamtvolumen 58 l 2 Behälterdeckel 29 l
Montageart:	Bodenmontage
Auszugsschienen:	gedämpfter Selbsteinzug
Systemtiefe:	530 mm
Farbe:	Metallteile silberfarben, Kunststoffteile hellgrau
Produktmaße (B x T x H):	350 x 530 x 523 mm
Verpackungsmaße (B x T x H):	365 x 355 x 585 mm
Gewicht mit Verpackung:	12 kg

Für Schränke mit 400 mm Breite mit Frontauszug.

For cabinets with front-mount-door of 400 mm width.

Separation: 2-fold
Inner bins: 1 x 38 l, 1 x 7 l, Total capacity 45 l
Type of installation: side-wall-mounted, self-adjusting to 16 - 19 mm side walls
Slides: covered, dampened slides with self-closing device with fully synchronized over-travel
System-depth : 528 mm
Lid: Sheet metal system Lid
Colour: Metal parts silver-coloured, Plastic parts light-grey
Product dimensions (W x D x H): 362-368 x 528 x 545 mm
Packing dimensions (W x D x H): 490 x 320 x 620 mm
Weight incl. packing: 13,6 kg

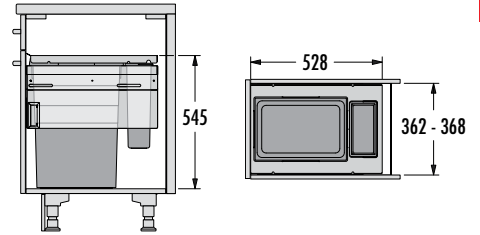

Separation: 2-fold
Inner bins: 2 x 24 l, Total capacity 48 l
 2 x Lid 24 l
Type of installation: bottom-mounted
Slides: dampened slides with self-closing device
System-depth: 530 mm
Colour: Metal parts silver-coloured, Plastic parts light grey
Product dimensions (W x D x H): 350 x 530 x 385 mm
Packing dimensions (W x D x H): 365 x 355 x 585 mm
Weight incl. packing: 9,9 kg

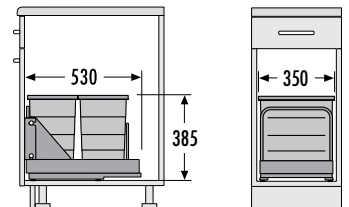

Separation: 2-fold
Inner bins: 2 x 29 l, Total capacity 58 l, 2 x Lid 29 l
Type of installation: bottom-mounted
Slides: dampened slides with self-closing device
System-depth: 530 mm
Colour: Metal parts silver-coloured, Plastic parts light grey
Product dimensions (W x D x H): 350 x 530 x 523 mm
Packing dimensions (W x D x H): 365 x 355 x 585 mm
Weight incl. packing: 12 kg

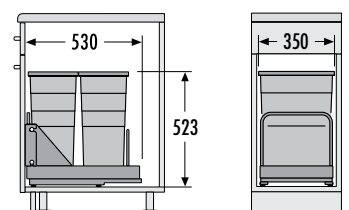

30 cm

40 cm

45 cm

50 cm

60 cm

80 cm

90 cm

Inch

**THE
SIN**



Übrigens, wussten Sie, ...

By the way, did you know ...

... dass die Marke HAILO in Deutschland einen Bekanntheitsgrad von etwa 68 % besitzt?

... that the HAILO brand enjoys a recognition factor of approx. 68 % in Germany?

40 CM



Einsatz für Schubkästen mit 400 mm Breite.
For common drawer cabinets of 400 mm width.



40 CM INSET.

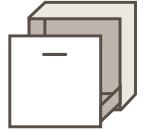

HAILO Wertstoffbox. *HAILO Built-in recycling bin.*

3273101



Abfalleimer:	1 x 53 l
Montageart:	Schubkastenmontage
Deckel:	Kunststoff-Schwingdeckel
Farbe:	Metall- und Kunststoffteile schwarz
Produktmaße (B x T x H):	340 x 260 x 622 mm
Verpackungsmaße (B x T x H):	355 x 265 x 640 mm
Gewicht mit Verpackung:	5,1 kg

Einsatz für Schubkästen mit 400 mm Breite.

For common drawer cabinets of 400 mm width.

Inner bin: 1 x 53 l
Type of installation: inside available drawer
Lid: Plastic swing lid
Colour: Metal and plastic parts black
Product dimensions (W x D x H): 340 x 260 x 622 mm
Packing dimensions (W x D x H): 355 x 265 x 640 mm
Weight incl. packing: 5,1 kg

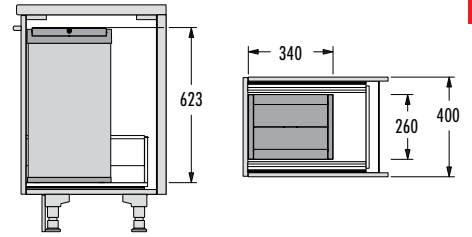

30 cm

40 cm

45 cm

50 cm

60 cm

80 cm

90 cm

Inch

S
W
I
N
G

Übrigens, wussten Sie, ...

By the way, did you know ...

... dass HAILO Einbau-Abfallsammler ausnahmslos in Deutschland hergestellt werden?

... that HAILO built-in waste separation systems are exclusively manufactured in Germany?

45 CM



Für Schränke ab 450 mm Breite mit Drehtür.
For hinged door cabinets from 450 mm width.



45 CM SWING.



HAILO AS Uno 18 weiß.

3418001



Abfalleimer:	1 x 18 l
Montageart:	Seitenwandmontage mit Türmitnehmer
Deckel:	Automatischer Dreh-Kipp-Deckel
Farbe:	Metall- und Kunststoffteile weiß
Produktmaße (B x T x H):	388 x 203 x 420 mm
Verpackungsmaße (B x T x H):	395 x 206 x 405 mm
Gewicht mit Verpackung:	3,1 kg
Kann links- wie rechtsseitig montiert werden	

HAILO AS Uno 18 Edelstahl/schwarz.

3418101



Abfalleimer:	1 x 18 l
Montageart:	Seitenwandmontage mit Türmitnehmer
Deckel:	Automatischer Dreh-Kipp-Deckel
Farbe:	Metallteile Edelstahl, Kunststoffteile schwarz
Produktmaße (B x T x H):	388 x 203 x 420 mm
Verpackungsmaße (B x T x H):	395 x 206 x 405 mm
Gewicht mit Verpackung:	3,1 kg
Kann links- wie rechtsseitig montiert werden	

HAILO AS Uno 18 Edelstahl/weiß.

3418901



Abfalleimer:	1 x 18 l
Montageart:	Seitenwandmontage mit Türmitnehmer
Deckel:	Automatischer Dreh-Kipp-Deckel
Farbe:	Metallteile Edelstahl, Kunststoffteile weiß
Produktmaße (B x T x H):	388 x 203 x 420 mm
Verpackungsmaße (B x T x H):	395 x 206 x 405 mm
Gewicht mit Verpackung:	3,1 kg
Kann links- wie rechtsseitig montiert werden	

Für Schränke ab 450 mm Breite mit Drehtür.

For hinged door cabinets from 450 mm width.

Passend für Schränke
Suitable for cabinets

45 50 60 cm

Inner bin: 1 x 18 l
Type of installation: side-wall-mounted, with door follower
Lid: Lid with turn & tilt mechanism
Colour: Metal and plastic parts white
Product dimensions (W x D x H): 388 x 203 x 420 mm
Packing dimensions (W x D x H): 395 x 206 x 405 mm
Weight incl. packing: 3,1 kg
 May be installed on left or on right sidewall

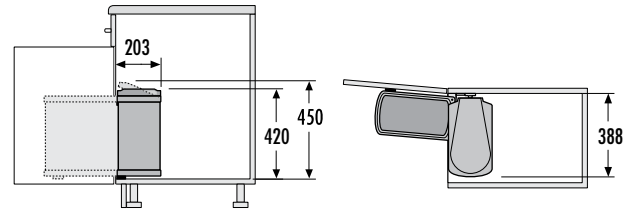

30 cm

40 cm

45 cm

50 cm

Passend für Schränke
Suitable for cabinets

45 50 60 cm

Inner bin: 1 x 18 l
Type of installation: side-wall-mounted, with door follower
Lid: Lid with turn & tilt mechanism
Colour: Metal parts stainless steel, Plastic parts black
Product dimensions (W x D x H): 388 x 203 x 420 mm
Packing dimensions (W x D x H): 395 x 206 x 405 mm
Weight incl. packing: 3,1 kg
 May be installed on left or on right sidewall

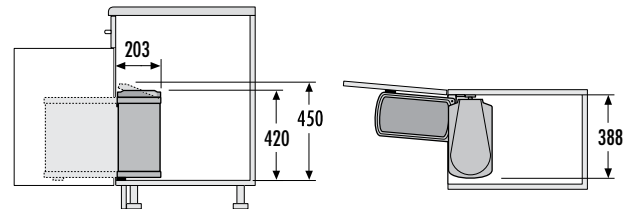

60 cm

80 cm

90 cm

Inch

Passend für Schränke
Suitable for cabinets

45 50 60 cm

Inner bin: 1 x 18 l
Type of installation: side-wall-mounted, with door follower
Lid: Lid with turn & tilt mechanism
Colour: Metal parts stainless steel, Plastic parts white
Product dimensions (W x D x H): 388 x 203 x 420 mm
Packing dimensions (W x D x H): 395 x 206 x 405 mm
Weight incl. packing: 3,1 kg
 May be installed on left or on right sidewall

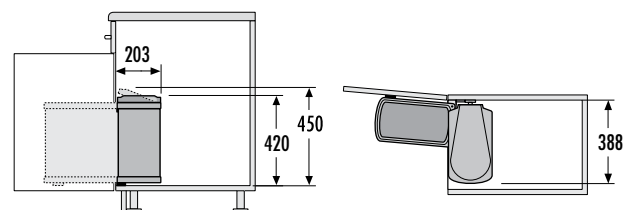

45 CM SWING.



HAILO AS Duo 8/8 weiß.

3416001



Trennung:	2-fach
Abfalleimer:	2 x 8 l, Gesamtvolumen 16 l
Montageart:	Seitenwandmontage mit Türmitnehmer
Deckel:	Automatischer Dreh-Kipp-Deckel
Farbe:	Metall- und Kunststoffteile weiß
Produktmaße (B x T x H):	388 x 203 x 420 mm
Verpackungsmaße (B x T x H):	395 x 206 x 405 mm
Gewicht mit Verpackung:	4,2 kg
Kann links- wie rechtsseitig montiert werden	

HAILO AS Duo 8/8 Edelstahl/schwarz.

3416101



Trennung:	2-fach
Abfalleimer:	2 x 8 l, Gesamtvolumen 16 l
Montageart:	Seitenwandmontage mit Türmitnehmer
Deckel:	Automatischer Dreh-Kipp-Deckel
Farbe:	Metallteile Edelstahl, Kunststoffteile schwarz
Produktmaße (B x T x H):	388 x 203 x 420 mm
Verpackungsmaße (B x T x H):	395 x 206 x 405 mm
Gewicht mit Verpackung:	4,2 kg
Kann links- wie rechtsseitig montiert werden	

HAILO AS Duo 8/8 Edelstahl/weiß.

3416901



Trennung:	2-fach
Abfalleimer:	2 x 8 l, Gesamtvolumen 16 l
Montageart:	Seitenwandmontage mit Türmitnehmer
Deckel:	Automatischer Dreh-Kipp-Deckel
Farbe:	Metallteile Edelstahl, Kunststoffteile weiß
Produktmaße (B x T x H):	388 x 203 x 420 mm
Verpackungsmaße (B x T x H):	395 x 206 x 405 mm
Gewicht mit Verpackung:	4,2 kg
Kann links- wie rechtsseitig montiert werden	

Für Schränke ab 450 mm Breite mit Drehtür.

For hinged door cabinets from 450 mm width.

Passend für Schränke
Suitable for cabinets

45 50 60 cm

Separation: 2-fold
 Inner bins: 2 x 8 l, Total capacity 16 l
Type of installation: **side-wall-mounted**, with door follower
 Lid: Lid with turn & tilt mechanism
 Colour: Metal and plastic parts white
 Product dimensions (W x D x H): 388 x 203 x 420 mm
 Packing dimensions (W x D x H): 395 x 206 x 405 mm
 Weight incl. packing: 4,2 kg
 May be installed on left or on right sidewall



3416001



4 007126 341600

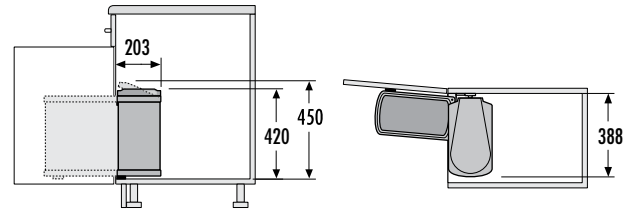

30 cm

40 cm

45 cm

50 cm

Passend für Schränke
Suitable for cabinets

45 50 60 cm

Separation: 2-fold
 Inner bins: 2 x 8 l, Total capacity 16 l
Type of installation: **side-wall-mounted**, with door follower
 Lid: Lid with turn & tilt mechanism
 Colour: Metal parts stainless steel, Plastic parts black
 Product dimensions (W x D x H): 388 x 203 x 420 mm
 Packing dimensions (W x D x H): 395 x 206 x 405 mm
 Weight incl. packing: 4,2 kg
 May be installed on left or on right sidewall



3416101



4 007126 341617

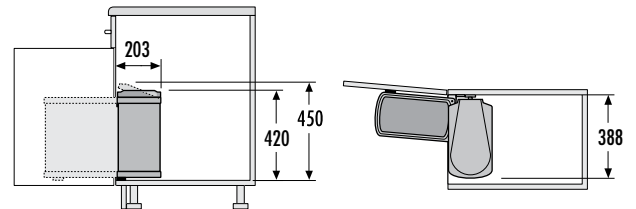

60 cm

80 cm

90 cm

Inch

Passend für Schränke
Suitable for cabinets

45 50 60 cm

Separation: 2-fold
 Inner bins: 2 x 8 l, Total capacity 16 l
Type of installation: **side-wall-mounted**, with door follower
 Lid: Lid with turn & tilt mechanism
 Colour: Metal parts stainless steel, Plastic parts white
 Product dimensions (W x D x H): 388 x 203 x 420 mm
 Packing dimensions (W x D x H): 395 x 206 x 405 mm
 Weight incl. packing: 4,2 kg
 May be installed on left or on right sidewall



3416901



4 007126 341693

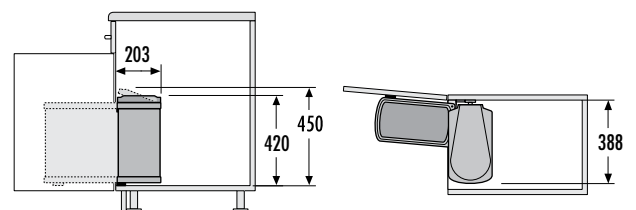

70 cm

75 cm

80 cm

85 cm

90 cm

95 cm

71



Übrigens, wussten Sie, ...

By the way, did you know ...

... dass HAILO Einbautechnik-Produkte mit über 100.000 Auszugszyklen getestet werden, bevor sie auf den Markt kommen?

... that HAILO Built-In Technology Products are tested on more than 100,000 pull-out cycles before they reach the market?

45 CM



Für Schränke mit 450 mm Breite mit Frontauszug.

For cabinets with front-mount-door of 450 mm width.



45 CM SLIDE.

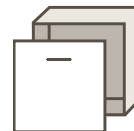

HAILO AS Cargo Synchro 450 18/18.

3608471



Trennung:	2-fach
Abfalleimer:	2 x 18 l, Gesamtvolumen 36 l
Montageart:	Seitenwandmontage, selbstjustierend 16 - 19 mm
Auszugsschienen:	abgedeckter, gedämpfter Selbsteinzug mit synchronisiertem Überauszug
Systemtiefe:	400 mm
Deckel:	Herausfahrbarer Systemdeckel aus Metall/Kunststoff, vollflächig belegt mit rutschfester Gummimatte
Farbe:	Metall- und Kunststoffteile dunkelgrau
Produktmaße (B x T x H):	412-418 x 400 x 424 mm
Verpackungsmaße (B x T x H):	555 x 280 x 490 mm
Gewicht mit Verpackung:	10,2 kg

HAILO AS Cargo Synchro 450 55.

3608461



Abfalleimer:	1 x 55 l
Montageart:	Seitenwandmontage, selbstjustierend 16 - 19 mm
Auszugsschienen:	abgedeckter, gedämpfter Selbsteinzug mit synchronisiertem Überauszug
Systemtiefe:	400 mm
Deckel:	Herausfahrbarer Systemdeckel aus Metall/Kunststoff, vollflächig belegt mit rutschfester Gummimatte
Farbe:	Metall- und Kunststoffteile dunkelgrau
Produktmaße (B x T x H):	412-418 x 400 x 544 mm
Verpackungsmaße (B x T x H):	485 x 445 x 530 mm
Gewicht mit Verpackung:	10,5 kg

HAILO AS Euro Cargo 450 38/38 dunkelgrau.

3619731



Trennung:	2-fach
Abfalleimer:	2 x 38 l, Gesamtvolumen 76 l
Montageart:	Seitenwandmontage, selbstjustierend 16 - 19 mm
Auszugsschienen:	abgedeckter, gedämpfter Selbsteinzug mit synchronisiertem Überauszug
Systemtiefe:	528 mm
Deckel:	Metallsystemdeckel
Farbe:	Metall- und Kunststoffteile dunkelgrau
Produktmaße (B x T x H):	412-418 x 528 x 545 mm
Verpackungsmaße (B x T x H):	490 x 320 x 620 mm
Gewicht mit Verpackung:	13 kg

Für Schränke mit 450 mm Breite mit Frontauszug.

For cabinets with front-mount-door of 450 mm width.

Separation: 2-fold
Inner bins: 2 x 18 l, Total capacity 36 l
Type of installation: side-wall-mounted, self-adjusting to 16 - 19 mm side walls
Slides: covered, dampened slides with self-closing device with fully synchronized over-travel
System-depth: 400 mm
Lid: Pullout metal/plastic system lid, with anti-slip rubber mat
Colour: Metal and plastic parts dark grey
Product dimensions (W x D x H): 412-418 x 400 x 424 mm
Packing dimensions (W x D x H): 555 x 280 x 490 mm
Weight incl. packing: 10,2 kg

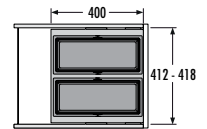
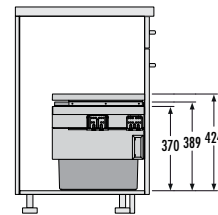

Inner bin: 1 x 55 l
Type of installation: side-wall-mounted, self-adjusting to 16 - 19 mm side walls
Slides: covered, dampened slides with self-closing device with fully synchronized over-travel
System-depth: 400 mm
Lid: Pullout metal/plastic system lid, with anti-slip rubber mat
Colour: Metal and plastic parts dark grey
Product dimensions (W x D x H): 412-418 x 400 x 544 mm
Packing dimensions (W x D x H): 485 x 445 x 530 mm
Weight incl. packing: 10,5 kg

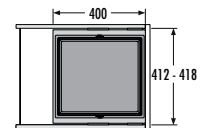
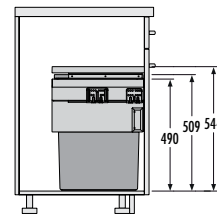

Separation: 2-fold
Inner bin: 2 x 38 l, Total capacity 76 l
Type of installation: side-wall-mounted, self-adjusting to 16 - 19 mm side walls
Slides: covered, dampened slides with self-closing device with fully synchronized over-travel
System-depth: 528 mm
Lid: Sheet metal system lid
Colour: Metal and plastic parts dark grey
Product dimensions (W x D x H): 412-418 x 528 x 545 mm
Packing dimensions (W x D x H): 490 x 320 x 620 mm
Weight incl. packing: 13 kg

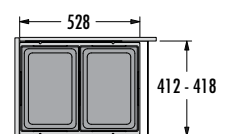
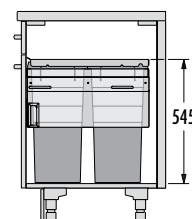

30 cm

40 cm

45 cm

50 cm

60 cm

80 cm

90 cm

Inch

45 CM SLIDE.

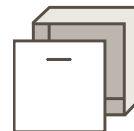

HAILO AS Euro Cargo 450 38/38.

3619471



Trennung:	2-fach
Abfalleimer:	2 x 38 l, Gesamtvolumen 76 l
Montageart:	Seitenwandmontage, selbstjustierend 16 - 19 mm
Auszugsschienen:	abgedeckter, gedämpfter Selbsteinzug mit synchronisiertem Überauszug
Systemtiefe:	528 mm
Deckel:	Metallsystemdeckel
Farbe:	Metallteile silberfarben, Kunststoffteile hellgrau
Produktmaße (B x T x H):	412- 418 x 528 x 545 mm
Verpackungsmaße (B x T x H):	490 x 320 x 620 mm
Gewicht mit Verpackung:	13 kg

HAILO AS Euro Cargo S 450 19/19.

3610471



Trennung:	2-fach
Abfalleimer:	2 x 19 l, Gesamtvolumen 38 l
Montageart:	Seitenwandmontage, selbstjustierend 16 - 19 mm
Auszugsschiene:	abgedeckter, gedämpfter Selbsteinzug mit synchronisiertem Überauszug
Systemtiefe:	448 mm
Deckel:	Metallsystemdeckel
Farbe:	Metallteile silberfarben, Kunststoffteile hellgrau
Produktmaße (B x T x H):	412- 418 x 403 x 439 mm
Verpackungsmaße (B x T x H):	510 x 260 x 420 mm
Gewicht mit Verpackung:	10,8 kg

HAILO AS Cargo 450 21/17.

3610811



Trennung:	2-fach
Abfalleimer:	1 x 21 l, 1 x 17 l, Gesamtvolumen 38 l
Montageart:	Seitenwandmontage, selbstjustierend 16 - 19 mm
Auszugsschienen:	abgedeckter, gedämpfter Selbsteinzug mit synchronisiertem Überauszug
Systemtiefe:	448 mm
Deckel:	Metallsystemdeckel
Farbe:	Metall- und Kunststoffteile dunkelgrau
Produktmaße (B x T x H):	412-418 x 434 x 370 mm
Verpackungsmaße (B x T x H):	500 x 250 x 410 mm
Gewicht mit Verpackung:	9,9 kg

Für Schränke mit 450 mm Breite mit Frontauszug.

For cabinets with front-mount-door of 450 mm width.

Separation: 2-fold
Inner bins: 2 x 38 l, Total capacity 76 l
Type of installation: side-wall-mounted, self-adjusting to 16 - 19 mm side walls
Slides: covered, dampened slides with self-closing device with fully synchronized over-travel
System-depth: 528 mm
Lid: Sheet metal system Lid
Colour: Metal parts silver-coloured, Plastic parts light-grey
Product dimensions (W x D x H): 412- 418 x 528 x 545 mm
Packing dimensions (W x D x H): 490 x 320 x 620 mm
Weight incl. packing: 13 kg

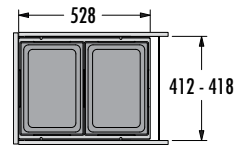
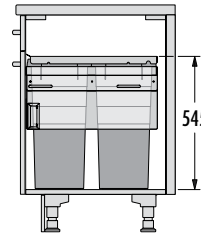

Separation: 2-fold
Inner bins: 2 x 19 l, Total capacity 38 l
Type of installation: side-wall-mounted, self-adjusting to 16 - 19 mm side walls
Slides: covered, dampened slides with self-closing device with fully synchronized over-travel
System-depth: 448 mm
Lid: Sheet metal system Lid
Colour: Metal parts silver-coloured, plastic parts light grey
Product dimensions (W x D x H): 412- 418 x 403 x 439 mm
Packing dimensions (W x D x H): 510 x 260 x 420 mm
Weight incl. packing: 10,8 kg

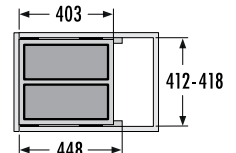
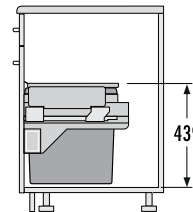

Separation: 2-fold
Inner bins: 1 x 21 l, 1 x 17 l, Total capacity 38 l
Type of installation: side-wall-mounted, self-adjusting to 16 - 19 mm side walls
Slides: covered, dampened slides with self-closing device with fully synchronized over-travel
System-depth: 448 mm
Lid: Sheet metal system Lid
Colour: Metal and plastic parts dark grey
Product dimensions (W x D x H): 412- 418 x 334 x 370 mm
Packing dimensions (W x D x H): 500 x 250 x 410 mm
Weight incl. packing: 9,9 kg

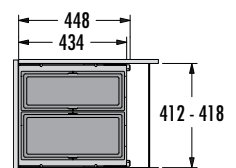
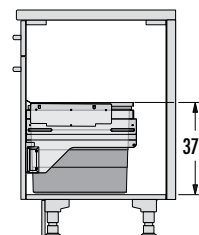

30 cm

40 cm

45 cm

50 cm

60 cm

80 cm

90 cm

Inch

45 CM SLIDE.



HAILO AS Cargo Soft short 450 14/14.

3610481



Trennung:	2-fach
Abfalleimer:	2 x 14 l, Gesamtvolumen 28 l
Montageart:	Seitenwandmontage, selbstjustierend 16 - 19 mm
Auszugsschiene:	abgedeckter, gedämpfter Selbsteinzug
Systemtiefe:	448 mm
Deckel:	Metallsystemdeckel
Farbe:	Metallteile silberfarben, Kunststoffteile hellgrau
Produktmaße (B x T x H):	412- 418 x 332 x 370 mm
Verpackungsmaße (B x T x H):	510 x 260 x 420 mm
Gewicht mit Verpackung:	11 kg

Für Schränke mit 450 mm Breite mit Frontauszug.

For cabinets with front-mount-door of 450 mm width.

Separation:	2-fold
Inner bins:	2 x 14 l, Total capacity 28 l
Type of installation:	side-wall-mounted, self-adjusting to 16 - 19 mm side walls, mounts also under sink
Slides:	covered, dampened slides with self-closing device
System-depth:	448 mm
Lid:	Sheet metal system Lid
Colour:	Metal parts silver-coloured, plastic parts light grey
Product dimensions (W x D x H):	412- 418 x 332 x 370 mm
Packing dimensions (W x D x H):	510 x 260 x 420 mm
Weight incl. packing:	11 kg



3610481



4 007126 362544

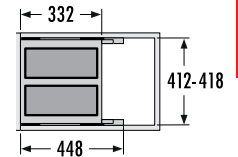
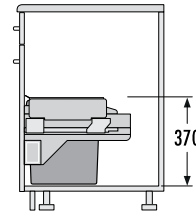

30 cm

40 cm

45 cm

50 cm

60 cm

80 cm

90 cm

Inch

45 CM SLIDE.



HAILO Kick and Go.

3691301



Fußhebel

"Kick and go" für Frontauszüge
und untere Schubkästen

siehe Seite 212

HAILO Libero 3.0.

3697301



Elektronischer Türöffner

HAILO Libero – Hands Free Opener

Der Laser-Sensoröffner von HAILO für ein automatisches,
komfortables Öffnen aller Abfalltrennsysteme mit
Frontanbindung und aller Auszugssysteme.

Einfache Bedienung durch Fußsensor und / oder
Sprachsteuerung.

Ausführliche Beschreibung Seite 210

Für Schränke mit Frontauszug.

For cabinets with front-mount-door.

Foot Pedal

"Kick and go" for Front mounted door and lower drawer

More information: page 212



3691301



4 007126 369123

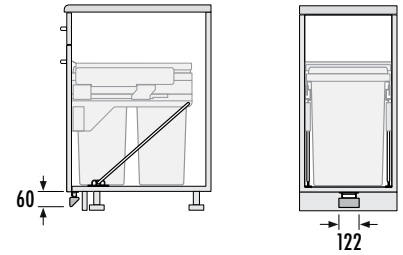

30 cm

40 cm

45 cm

50 cm

60 cm

80 cm

90 cm

Inch

Electronic Door Opener

HAILO „Liberio“ – Hands Free Opener

HAILO's electronic sensor-opener Liberio 3.0 for front-mount-doors and drawers offers an automatic, comfortable hands-free opening of all waste-recycling-systems with attached door-panel, and of any common, also damped, drawer-mounted systems. Easy operation by laser-sensor and / or optionally voice activated.

More information: page 210



3697301



4 007126 301000

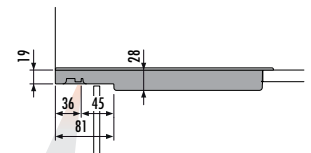
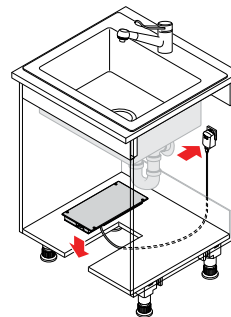

**H
E
S
N
I**



Übrigens, wussten Sie, ...

By the way, did you know ...

... dass HAILO im Verzeichnis „Marken des Jahrhunderts“ neben anderen 300 Premiummarken vertreten ist?

... that HAILO is amongst 300 premium brands listed in the "Brands of the Century" guide?

45 CM



Einsatz für Schubkästen mit 450 mm Breite.
For common drawer cabinets of 450 mm width.



45 CM INSET.

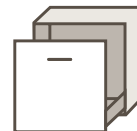

HAILO AS Triple XL 450 55.



3631481

Abfalleimer:	1 x 55 l
Montageart:	Schubkastenmontage , Seitenwandstärke 16 - 19 mm
Schubkasten Nenntiefe:	≥ 420 mm
Deckel:	Metall-Systemdeckel
Farbe:	Metall- und Kunststoffteile dunkelgrau
Produkt-Maße (T x H):	400 x 522 mm
Verpackungsmaße (B x T x H):	474 x 435 x 504 mm
Gewicht mit Verpackung:	6,2 kg

HAILO AS Triple XL 450 18/18.

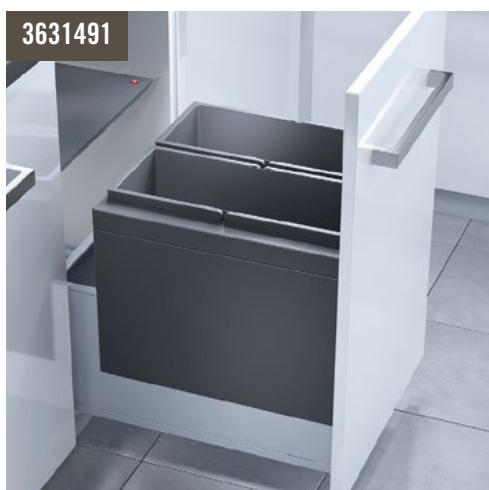

3631491

Trennung:	2-fach
Abfalleimer:	2 x 18 l, Gesamtvolumen 36 l,
Montageart:	Schubkastenmontage , Seitenwandstärke 16 - 19 mm
Schubkasten Nenntiefe:	≥ 420 mm
Deckel:	Metall-Systemdeckel
Farbe:	Metall- und Kunststoffteile dunkelgrau
Produkt-Maße (T x H):	400 x 402 mm
Verpackungsmaße (B x T x H):	425 x 220 x 500 mm
Gewicht mit Verpackung:	8,1 kg

HAILO AS XXL 450 18/D/12/P/U.



3630451

Trennung:	2-fach
Abfalleimer:	1 x 18 l, 1 x 12 l, Gesamtvolumen 30 l, 1 x Putzmittelkorb 4,1 l, 1 x Behälterdeckel 18 l, 1 x Utensiliendepot
Montageart:	Schubkastenmontage , Seitenwandstärke 16 - 19 mm
Schubkasten Nenntiefe:	≥ 500 mm
Deckel:	Metall-Systemdeckel
Farbe:	Metallteile silberfarben, Kunststoffteile grau
Produkt-Maße (T x H):	433 x 330 mm
Verpackungsmaße (B x T x H):	425 x 315 x 455 mm
Gewicht mit Verpackung:	8,1 kg
Nicht für Blum Legra Box F	

Einsatz für Schubkästen mit 450 mm Breite.

For common drawer cabinets of 450 mm width.

Inner bins: 1 x 55 l
Type of installation: **inside available drawer,**
side-wall-thickness 16 - 19 mm
Nominal drawer-depth: ≥ 420 mm
Lid: Sheet metal system Lid
Colour: Metal and plastic parts dark grey
Product dimensions (D x H): 400 x 522 mm
Packing dimensions (W x D x H): 474 x 435 x 504 mm
Weight incl. packing: 6,2 kg



3631481



4 007126 364333

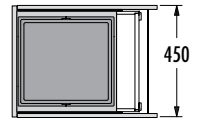
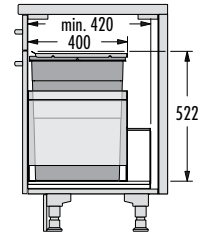

30 cm

40 cm

45 cm

50 cm

60 cm

80 cm

90 cm

Inch

Separation: 2-fold
Inner bins: 2 x 18 l, Total capacity 36 l
Type of installation: **inside available drawer,**
side-wall-thickness 16 - 19 mm
Nominal drawer-depth: ≥ 420 mm
Lid: Sheet metal system Lid
Colour: Metal and plastic parts dark grey
Product dimensions (D x H): 400 x 402 mm
Packing dimensions (W x D x H): 425 x 220 x 500 mm
Weight incl. packing: 8,1 kg



3631491



4 007126 364340

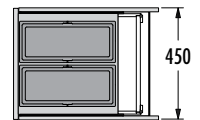
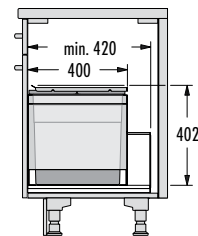

Separation: 2-fold
Inner bins: 1 x 18 l, 1 x 12 l, Total capacity 30 l
 1 x Cleansers basket 4.1 l, 1 x Lid 18 l, 1 x utensil depot
Type of installation: **inside available drawer,**
side-wall-thickness 16 - 19 mm
Nominal drawer-depth: ≥ 500 mm
Lid: Sheet metal system Lid
Colour: Metal parts silver-coloured, plastic parts grey
Product dimensions (D x H): 433 x 330 mm
Packing dimensions (W x D x H): 425 x 315 x 455 mm
Weight incl. packing: 8,1 kg
Not suitable for Blum Legra Box F



3630451



4 007126 304506

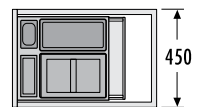
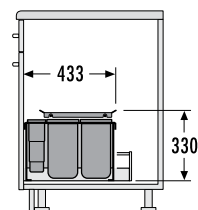

45 CM INSET.

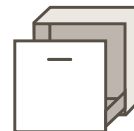

HAILO AS Separato K 450 18/8/8/D.

3620461



Trennung:	3-fach
Abfalleimer:	1 x 18 l, 2 x 8 l, Gesamtvolumen 34 l, 1 x Behälterdeckel 8 l
Montageart:	Schubkastenmontage, Seitenwandstärke 16 - 19 mm
Schubkasten Nenntiefe:	≥ 500 mm
Deckel:	Kunststoff-Deckel herausziehbar, Seitenwandmontage
Farbe:	Kunststoffteile hellgrau
Produktmaße (B x T x H):	407 x 491 x 340 mm
Verpackungsmaße (B x T x H):	510 x 420 x 285 mm
Gewicht mit Verpackung:	3,7 kg
Nicht für Blum Legra Box F	

HAILO AS Separato K 450 18/8/8/D dunkelgrau.

3620471



Trennung:	3-fach
Abfalleimer:	1 x 18 l, 2 x 8 l, Gesamtvolumen 34 l, 1 x Behälterdeckel 8 l
Montageart:	Schubkastenmontage, Seitenwandstärke 16 - 19 mm
Schubkasten Nenntiefe:	≥ 500 mm
Deckel:	Kunststoff-Deckel herausziehbar, Seitenwandmontage
Farbe:	Kunststoffteile dunkelgrau
Produktmaße (B x T x H):	407 x 491 x 340 mm
Verpackungsmaße (B x T x H):	510 x 420 x 285 mm
Gewicht mit Verpackung:	3,7 kg
Nicht für Blum Legra Box F	

Einsatz für Schubkästen mit 450 mm Breite.

For common drawer cabinets of 450 mm width.

Separation: 3-fold
Inner bins: 1 x 18 l, 2 x 8 l, Total capacity 34 l, 1 x Lid 8 l
Type of installation: **inside available drawer,**
 side-wall-thickness 16 - 19 mm

Nominal drawer-depth: ≥ 500 mm
Lid: Plastic-lid single extension, sidewall-mounted
Colour: Plastic parts light-grey
Product dimensions (W x D x H): 407 x 491 x 340 mm
Packing dimensions (W x D x H): 510 x 420 x 285 mm
Weight incl. packing: 3,7 kg
 Not suitable for Blum Legra Box F



3620461



4 007126 362049

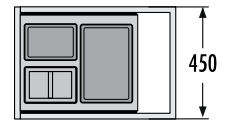
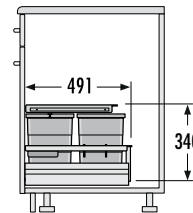

30 cm

40 cm

45 cm

50 cm

60 cm

80 cm

90 cm

Inch

Separation: 3-fold
Inner bins: 1 x 18 l, 2 x 8 l, Total capacity 34 l, 1 x Lid 8 l
Type of installation: **inside available drawer,**
 side-wall-thickness 16 - 19 mm

Nominal drawer-depth: ≥ 500 mm
Lid: Plastic-lid single extension, sidewall-mounted
Colour: Plastic parts dark-grey
Product dimensions (W x D x H): 407 x 491 x 340 mm
Packing dimensions (W x D x H): 510 x 420 x 285 mm
Weight incl. packing: 3,7 kg
 Not suitable for Blum Legra Box F



3620471



4 007126 305305

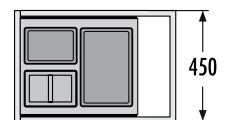
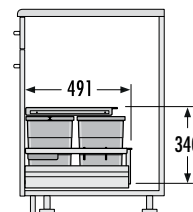



SWING

Übrigens, wussten Sie, ...

By the way, did you know ...

... dass HAILO Einbautechnik weltweit in über 80 Länder exportiert?

... that HAILO Built-In Technology exports to more than 80 countries around the world?

50 CM



Für Schränke ab 500 mm Breite mit Drehtür.
For hinged door cabinets from 500 mm width.



50 CM SWING.



HAILO AS Easy Cargo 30/19.



3668501

Trennung:	2-fach
Abfalleimer:	1 x 30 l, 1 x 19 l, Gesamtvolumen 49 l
Montageart:	Bodenmontage
Auszugsschienen:	Vollauszug
Farbe:	Metallteile silberfarben, Kunststoffteile hellgrau
Produktmaße (B x T x H):	430 x 465 x 455 mm
Verpackungsmaße (B x T x H):	455 x 510 x 470 mm
Gewicht mit Verpackung:	8,1 kg
Praktische Ablagemulde im Deckel integriert	

HAILO AS Raumspar Tandem S 18/12.



3644701

Trennung:	2-fach
Abfalleimer:	1 x 18 l, 1 x 12 l, Gesamtvolumen 30 l
Montageart:	Bodenmontage
Auszugsschienen:	Vollauszug
Farbe:	Metallteile silberfarben, Kunststoffteile hellgrau
Produktmaße (B x T x H):	434 x 330 x 347 mm
Verpackungsmaße (B x T x H):	490 x 360 x 360 mm
Gewicht mit Verpackung:	5 kg
Praktische Ablagemulde im Deckel integriert	

HAILO AS Raumspar Tandem S 18/12 dunkelgrau.



3644901

Trennung:	2-fach
Abfalleimer:	1 x 18 l, 1 x 12 l, Gesamtvolumen 30 l
Montageart:	Bodenmontage
Auszugsschienen:	Vollauszug
Farbe:	Metallteile silberfarben, Kunststoffteile dunkelgrau
Produktmaße (B x T x H):	434 x 330 x 347 mm
Verpackungsmaße (B x T x H):	490 x 360 x 360 mm
Gewicht mit Verpackung:	5 kg
Praktische Ablagemulde im Deckel integriert	

Für Schränke ab 500 mm Breite mit Drehtür.

For hinged door cabinets from 500 mm width.

Passend für Schränke
Suitable for cabinets

50 60 cm

Separation: 2-fold
 Inner bins: 1 x 30 l, 1 x 19 l, Total capacity 49 l
Type of installation: **bottom-mounted**
 Slides: full extension
 Colour: Metal parts silver-coloured, Plastic parts light grey
 Product dimensions (W x D x H): 430 x 465 x 455 mm
 Packing dimensions (W x D x H): 455 x 510 x 470 mm
 Weight incl. packing: 8,1 kg
 Practical storage area integrated in the lid



3668501



4 007126 366856

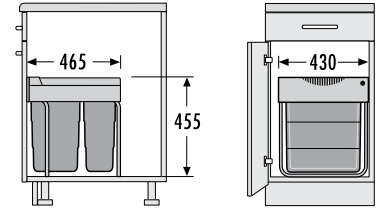

30 cm

40 cm

45 cm

50 cm

Passend für Schränke
Suitable for cabinets

50 60 cm

Separation: 2-fold
 Inner bins: 1 x 18 l, 1 x 12 l, Total capacity 30 l
Type of installation: **bottom-mounted**
 Slides: full extension
 Colour: Metal parts silver-grey, Plastic parts light grey
 Product dimensions (W x D x H): 434 x 330 x 347 mm
 Packing dimensions (W x D x H): 490 x 360 x 360 mm
 Weight incl. packing: 5 kg
 Practical storage area integrated in the lid



3644701



4 007126 364531

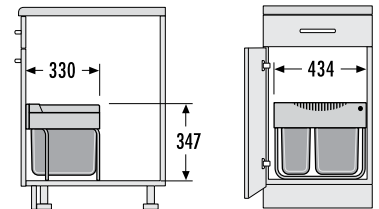

60 cm

80 cm

90 cm

Inch

Passend für Schränke
Suitable for cabinets

50 60 cm

Separation: 2-fold
 Inner bins: 1 x 18 l, 1 x 12 l, Total capacity 30 l
Type of installation: **bottom-mounted**
 Slides: full extension
 Colour: Metal parts silvercoloured, plastic parts dark grey
 Product dimensions (W x D x H): 434 x 330 x 347 mm
 Packing dimensions (W x D x H): 490 x 360 x 360 mm
 Weight incl. packing: 5 kg
 Practical storage area integrated in the lid



3644901



4 007126 302793

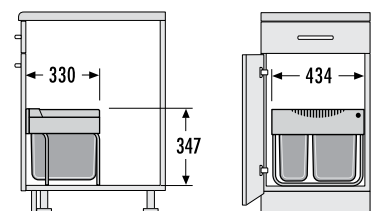

50 CM SWING.

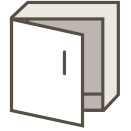

HAILO AS Raumspar Tandem S 12/8/8/D schwarz.



Trennung:	3-fach
Abfalleimer:	1 x 12 l, 2 x 8 l, Gesamtvolumen 28 l, 1 x Behälterdeckel 8 l
Montageart:	Bodenmontage
Auszugsschienen:	Vollauszug
Farbe:	Metallteile silberfarben, Kunststoffteile schwarz
Produktmaße (B x T x H):	434 x 330 x 347 mm
Verpackungsmaße (B x T x H):	490 x 360 x 360 mm
Gewicht mit Verpackung:	5 kg
Praktische Ablagemulde im Deckel integriert	
Kunststoffteile aus recyceltem Kunststoff	

HAILO AS Raumspar Tandem S 12/8/8/D dunkelgrau.



Trennung:	3-fach
Abfalleimer:	1 x 12 l, 2 x 8 l, Gesamtvolumen 28 l, 1 x Behälterdeckel 8 l
Montageart:	Bodenmontage
Auszugsschienen:	Vollauszug
Farbe:	Metallteile silberfarben, Kunststoffteile dunkelgrau
Produktmaße (B x T x H):	434 x 330 x 347 mm
Verpackungsmaße (B x T x H):	490 x 360 x 360 mm
Gewicht mit Verpackung:	5 kg
Praktische Ablagemulde im Deckel integriert	

HAILO AS Raumspar Tandem S 12/8/8/D.



Trennung:	3-fach
Abfalleimer:	1 x 12 l, 2 x 8 l, Gesamtvolumen 28 l, 1 x Behälterdeckel 8 l
Montageart:	Bodenmontage
Auszugsschienen:	Vollauszug
Farbe:	Metallteile silberfarben, Kunststoffteile hellgrau
Produktmaße (B x T x H):	434 x 330 x 347 mm
Verpackungsmaße (B x T x H):	490 x 360 x 360 mm
Gewicht mit Verpackung:	5 kg
Praktische Ablagemulde im Deckel integriert	

Für Schränke ab 500 mm Breite mit Drehtür.

For hinged door cabinets from 500 mm width.

Passend für Schränke
Suitable for cabinets

50 60 cm

Separation: 3-fold
Inner bins: 1 x 12 l, 2 x 8 l, Total capacity 28 l,
1 x Lid 8 l

Type of installation: bottom-mounted
Slides: full extension
Colour: Metal parts silver, plastic parts black
Product dimensions (W x D x H): 434 x 330 x 347 mm
Packing dimensions (W x D x H): 490 x 360 x 360 mm
Weight incl. packing: 5 kg
Practical storage area integrated in the lid
Plastic parts made from recycled plastic



3644931



4 007126 306722

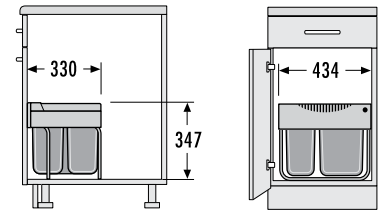

30 cm

40 cm

45 cm

50 cm

Passend für Schränke
Suitable for cabinets

50 60 cm

Separation: 3-fold
Inner bins: 1 x 12 l, 2 x 8 l, Total capacity 28 l,
1 x Lid 8 l

Type of installation: bottom-mounted
Slides: full extension
Colour: Metal parts silver, plastic parts dark grey
Product dimensions (W x D x H): 434 x 330 x 347 mm
Packing dimensions (W x D x H): 490 x 360 x 360 mm
Weight incl. packing: 5 kg
Practical storage area integrated in the lid



3644911



4 007126 302809

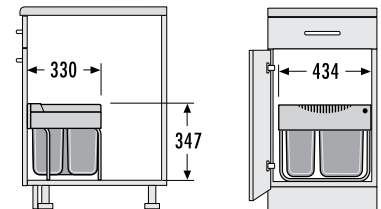

60 cm

80 cm

90 cm

Inch

Passend für Schränke
Suitable for cabinets

50 60 cm

Separation: 3-fold
Inner bins: 1 x 12 l, 2 x 8 l, Total capacity 28 l,
1 x Lid 8 l

Type of installation: bottom-mounted
Slides: full extension
Colour: Metal parts silver-coloured, Plastic parts light grey
Product dimensions (W x D x H): 434 x 330 x 347 mm
Packing dimensions (W x D x H): 490 x 360 x 360 mm
Weight incl. packing: 5 kg
Practical storage area integrated in the lid



3644731



4 007126 364555

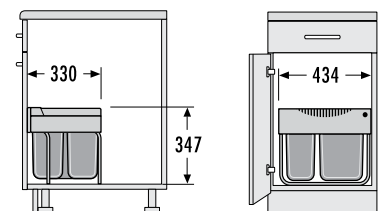



Übrigens, wussten Sie, ...

By the way, did you know ...

... dass HAILO Einbautechnik-Produkte mit über 100.000 Auszugszyklen getestet werden, bevor sie auf den Markt kommen?

... that HAILO Built-In Technology Products are tested on more than 100,000 pull-out cycles before they reach the market?

50 CM



Für Schränke mit 500 mm Breite mit Frontauszug.

For cabinets with front-mount-door of 500 mm width.



50 CM SLIDE.



HAILO AS Cargo Synchro 500 28/18.

3608521



Trennung:	2-fach
Abfalleimer:	1 x 28 l, 1 x 18 l, Gesamtvolumen 46 l
Montageart:	Seitenwandmontage, selbstjustierend 16 - 19 mm
Auszugsschienen:	abgedeckter, gedämpfter Selbsteinzug mit synchronisiertem Überauszug
Systemtiefe:	400 mm
Deckel:	Herausfahrbarer Systemdeckel aus Metall/Kunststoff, vollflächig belegt mit rutschfester Gummimatte
Farbe:	Metall- und Kunststoffteile dunkelgrau
Produktmaße (B x T x H):	462-468 x 400 x 424 mm
Verpackungsmaße (B x T x H):	645 x 400 x 440 mm
Gewicht mit Verpackung:	11,2 kg

HAILO AS Cargo Synchro 500 18/13/13/D.

3608531



Trennung:	3-fach
Abfalleimer:	1 x 18 l, 2 x 13 l, Gesamtvolumen 44 l, 1 x Behälterdeckel 13 l
Montageart:	Seitenwandmontage, selbstjustierend 16 - 19 mm
Auszugsschienen:	abgedeckter, gedämpfter Selbsteinzug mit synchronisiertem Überauszug
Systemtiefe:	400 mm
Deckel:	Herausfahrbarer Systemdeckel aus Metall/Kunststoff, vollflächig belegt mit rutschfester Gummimatte
Farbe:	Metall- und Kunststoffteile dunkelgrau
Produktmaße (B x T x H):	462-468 x 400 x 424 mm
Verpackungsmaße (B x T x H):	645 x 400 x 440 mm
Gewicht mit Verpackung:	11,5 kg

HAILO AS Euro Cargo 500 38/38 dunkelgrau.

3619721



Trennung:	2-fach
Abfalleimer:	2 x 38 l, Gesamtvolumen 76 l
Montageart:	Seitenwandmontage, selbstjustierend 16 - 19 mm
Auszugsschienen:	abgedeckter, gedämpfter Selbsteinzug mit synchronisiertem Überauszug
Systemtiefe:	528 mm
Deckel:	Metallsystemdeckel
Farbe:	Metall- und Kunststoffteile dunkelgrau
Produktmaße (B x T x H):	462- 468 x 528 x 545 mm
Verpackungsmaße (B x T x H):	490 x 320 x 620 mm
Gewicht mit Verpackung:	13,3 kg

Für Schränke mit 500 mm Breite mit Frontauszug.

For cabinets with front-mount-door of 500 mm width.

Separation: 2-fold
Inner bins: 1 x 28 l, 1 x 18 l, Total capacity 46 l
Type of installation: side-wall-mounted, self-adjusting to 16 - 19 mm side walls
Slides: covered, dampened slides with self-closing device with fully synchronized over-travel
System-depth: 400 mm
Lid: Pullout metal/plastic system lid, with anti-slip rubber mat
Colour: Metal and plastic parts dark grey
Product dimensions (W x D x H): 462-468 x 400 x 424 mm
Packing dimensions (W x D x H): 645 x 400 x 440 mm
Weight incl. packing: 11,2 kg

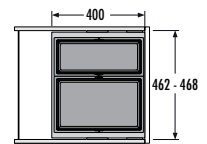
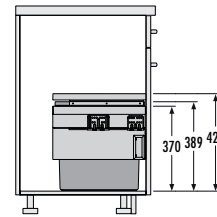

Separation: 3-fold
Inner bins: 1 x 18 l, 2 x 13 l, Total capacity 44 l, 1 x Lid 13 l
Type of installation: side-wall-mounted, self-adjusting to 16 - 19 mm side walls
Slides: covered, dampened slides with self-closing device with fully synchronized over-travel
System-depth: 400 mm
Lid: Pullout metal/ plastic system lid, with anti-slip rubber mat
Colour: Metal and plastic parts dark grey
Product dimensions (W x D x H): 462-468 x 400 x 424 mm
Packing dimensions (W x D x H): 645 x 400 x 440 mm
Weight incl. packing: 11,5 kg

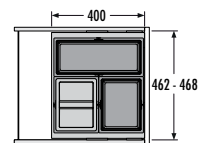
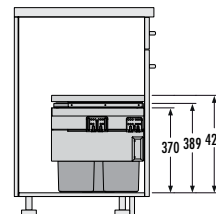

Separation: 2-fold
Inner bins: 2 x 38 l, Total capacity 76 l
Type of installation: side-wall-mounted, self-adjusting to 16 - 19 mm side walls
Slides: covered, dampened slides with self-closing device with fully synchronized over-travel
System-depth: 528 mm
Lid: Sheet metal system Lid
Colour: Metal and plastic parts dark grey
Product dimensions (W x D x H): 462- 468 x 528 x 545 mm
Packing dimensions (W x D x H): 490 x 320 x 620 mm
Weight incl. packing: 13,3 kg

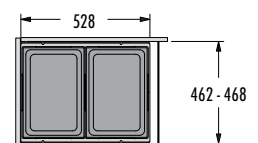
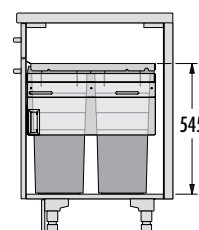

30 cm

40 cm

45 cm

50 cm

60 cm

80 cm

90 cm

Inch

50 CM SLIDE.



HAILO AS Euro Cargo 500 38/38.

3619531



Trennung:	2-fach
Abfalleimer:	2 x 38 l, Gesamtvolumen 76 l
Montageart:	Seitenwandmontage, selbstjustierend 16 - 19 mm
Auszugsschienen:	abgedeckter, gedämpfter Selbsteinzug mit synchronisiertem Überauszug
Systemtiefe:	528 mm
Deckel:	Metallsystemdeckel
Farbe:	Metallteile silberfarben, Kunststoffteile hellgrau
Produktmaße (B x T x H):	462- 468 x 528 x 545 mm
Verpackungsmaße (B x T x H):	490 x 320 x 620 mm
Gewicht mit Verpackung:	13,3 kg

HAILO AS Euro Cargo S 500 30/19.

3610521



Trennung:	2-fach
Abfalleimer:	1 x 30 l, 1 x 19 l, Gesamtvolumen 49 l
Montageart:	Seitenwandmontage, selbstjustierend 16 - 19 mm
Auszugsschienen:	abgedeckter, gedämpfter Selbsteinzug mit synchronisiertem Überauszug
Systemtiefe:	448 mm
Deckel:	Metallsystemdeckel
Farbe:	Metallteile silberfarben, Kunststoffteile hellgrau
Produktmaße (B x T x H):	462- 468 x 403 x 439 mm
Verpackungsmaße (B x T x H):	510 x 345 x 415 mm
Gewicht mit Verpackung:	11,1 kg

HAILO AS Cargo 500 28/17.

3610821



Trennung:	2-fach
Abfalleimer:	1 x 28 l, 1 x 17 l, Gesamtvolumen 45 l
Montageart:	Seitenwandmontage, selbstjustierend 16 - 19 mm
Auszugsschienen:	abgedeckter, gedämpfter Selbsteinzug mit synchronisiertem Überauszug
Systemtiefe:	448 mm
Deckel:	Metallsystemdeckel
Farbe:	Metall- und Kunststoffteile dunkelgrau
Produktmaße (B x T x H):	462-468 x 434 x 370 mm
Verpackungsmaße (B x T x H):	465 x 385 x 440 mm
Gewicht mit Verpackung:	10,6 kg

Für Schränke mit 500 mm Breite mit Frontauszug.

For cabinets with front-mount-door of 500 mm width.

Separation: 2-fold
Inner bins: 2 x 38 l, Total capacity 76 l
Type of installation: side-wall-mounted, self-adjusting to 16 - 19 mm side walls
Slides: covered, dampened slides with self-closing device with fully synchronized over-travel
System-depth: 528 mm
Lid: Sheet metal system Lid
Colour: Metal parts silver-coloured, Plastic parts light-grey
Product dimensions (W x D x H): 462- 468 x 528 x 545 mm
Packing dimensions (W x D x H): 490 x 320 x 620 mm
Weight incl. packing: 13,3 kg

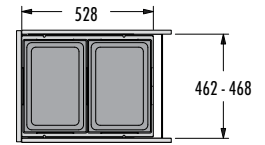
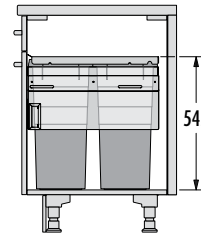

Separation: 2-fold
Inner bins: 1 x 30 l, 1 x 19 l, Total capacity 49 l
Type of installation: side-wall-mounted, self-adjusting to 16 - 19 mm side walls
Slides: covered, dampened slides with self-closing device with fully synchronized over-travel
System-depth: 448 mm
Lid: Sheet metal system Lid
Colour: Metal parts silver-coloured, plastic parts light grey
Product dimensions (W x D x H): 462- 468 x 403 x 439 mm
Packing dimensions (W x D x H): 510 x 345 x 415 mm
Weight incl. packing: 11,1 kg

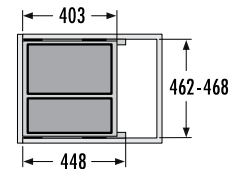
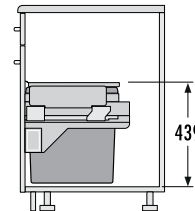

Separation: 2-fold
Inner bins: 1 x 28 l, 1 x 17 l, Total capacity 45 l
Type of installation: side-wall-mounted, self-adjusting to 16 - 19 mm side walls
Slides: covered, dampened slides with self-closing device with fully synchronized over-travel
System-depth: 448 mm
Lid: Sheet metal system Lid
Colour: Metal and plastic parts dark grey
Product dimensions (W x D x H): 462- 468 x 434 x 370 mm
Packing dimensions (W x D x H): 465 x 385 x 440 mm
Weight incl. packing: 10,6 kg

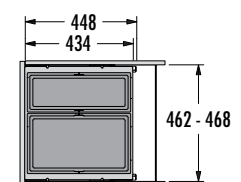
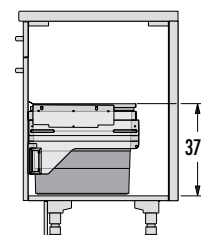

30 cm

40 cm

45 cm

50 cm

60 cm

80 cm

90 cm

Inch

50 CM SLIDE.

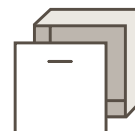

HAILO AS Cargo 500 17/13/13/D.



3610831

Trennung:	3-fach
Abfalleimer:	1 x 17 l, 2 x 13 l, Gesamtvolumen 43 l, 1 Behälterdeckel 13 l
Montageart:	Seitenwandmontage, selbstjustierend 16 - 19 mm
Auszugsschienen:	abgedeckter, gedämpfter Selbsteinzug mit synchronisiertem Überauszug
Systemtiefe:	448 mm
Deckel:	Metallsystemdeckel
Farbe:	Metall- und Kunststoffteile dunkelgrau
Produktmaße (B x T x H):	462-468 x 434 x 370 mm
Verpackungsmaße (B x T x H):	465 x 385 x 440 mm
Gewicht mit Verpackung:	10,9 kg

HAILO AS Cargo Soft short 500 20/14.



3610581

Trennung:	2-fach
Abfalleimer:	1 x 20 l, 1 x 14 l, Gesamtvolumen 34 l
Montageart:	Seitenwandmontage, selbstjustierend 16 - 19 mm
Auszugsschienen:	abgedeckter, gedämpfter Selbsteinzug
Systemtiefe:	448 mm
Deckel:	Metallsystemdeckel
Farbe:	Metallteile silberfarben, Kunststoffteile hellgrau
Produktmaße (B x T x H):	462- 468 x 332 x 370 mm
Verpackungsmaße (B x T x H):	510 x 345 x 415 mm
Gewicht mit Verpackung:	10,7 kg

Für Schränke mit 500 mm Breite mit Frontauszug.

For cabinets with front-mount-door of 500 mm width.

Separation: 3-fold
Inner bins: 1 x 17 l, 2 x 13 l, Total capacity 43 l, 1 x Lid 13 l
Type of installation: side-wall-mounted, self-adjusting to 16 - 19 mm side walls
Slides: covered, dampened slides with self-closing device with fully synchronized over-travel
System-depth: 448 mm
Lid: Sheet metal system Lid
Colour: Metal and plastic parts dark grey
Product dimensions (W x D x H): 462- 468 x 434 x 370 mm
Packing dimensions (W x D x H): 465 x 385 x 440 mm
Weight incl. packing: 10,9 kg



3610831



4 007126 301086

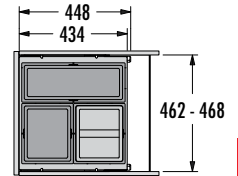
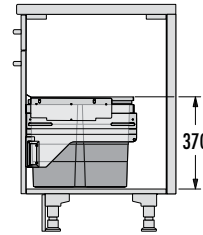

Separation: 2-fold
Inner bins: 1 x 20 l, 1 x 14 l, Total capacity 34 l
Type of installation: side-wall-mounted, self-adjusting to 16 - 19 mm side walls
Slides: covered, dampened slides with self-closing device
System-depth: 448 mm
Lid: Sheet metal system Lid
Colour: Metal parts silver-coloured, plastic parts light grey
Product dimensions (W x D x H): 462- 468 x 332 x 370 mm
Packing dimensions (W x D x H): 510 x 345 x 415 mm
Weight incl. packing: 10,7 kg



3610581



4 007126 362551

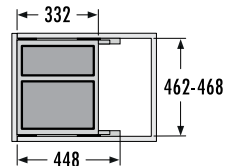
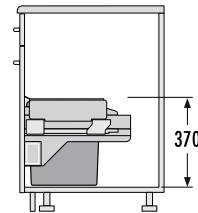

30 cm

40 cm

45 cm

50 cm

60 cm

80 cm

90 cm

Inch

50 CM SLIDE.

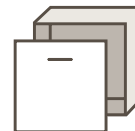

HAILO Kick and Go.

3691301

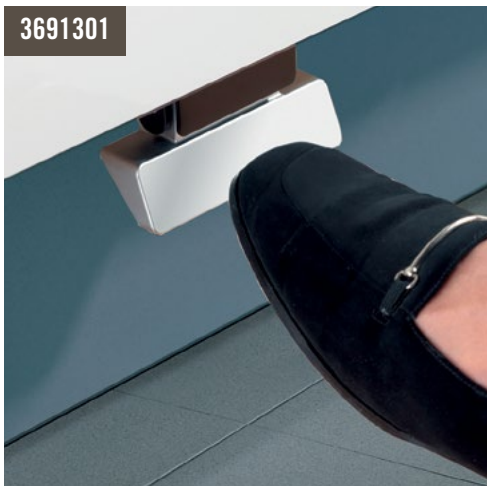

Fußhebel

"Kick and go" für Frontauszüge
und untere Schubkästen

siehe Seite 212

HAILO Libero 3.0.

3697301



Elektronischer Türöffner

HAILO Libero – Hands Free Opener

Der Laser-Sensoröffner von HAILO für ein automatisches,
komfortables Öffnen aller Abfalltrennsysteme mit
Frontanbindung und aller Auszugssysteme.

Einfache Bedienung durch Fußsensor und / oder
Sprachsteuerung.

Ausführliche Beschreibung Seite 210

Für Schränke mit Frontauszug.

For cabinets with front-mount-door.

Foot Pedal

"Kick and go" for Front mounted door and lower drawer

More information: page 212



3691301



4 007126 369123

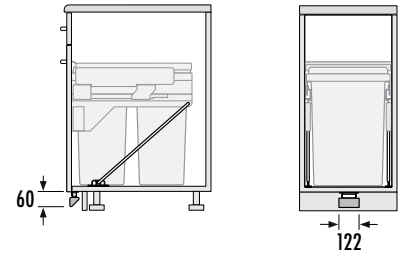

30 cm

40 cm

45 cm

50 cm

Electronic Door Opener

HAILO „Liberio“ – Hands Free Opener

HAILO's electronic sensor-opener Liberio 3.0 for front-mount-doors and drawers offers an automatic, comfortable hands-free opening of all waste-recycling-systems with attached door-panel, and of any common, also damped, drawer-mounted systems. Easy operation by laser-sensor and / or optionally voice activated.

More information: page 210



3697301



4 007126 301000

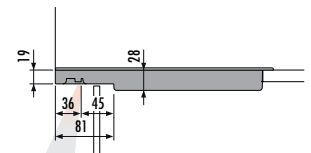
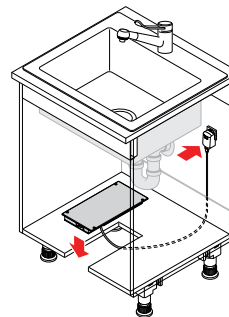

60 cm

80 cm

90 cm

Inch

**HA
ILO
S
N
I**



Übrigens, wussten Sie, ...

By the way, did you know ...

... dass HAILO die größte Eimervielfalt für jeden Bedarf vorhält?

... that HAILO provides the widest range of bins for all requirements?

50 CM



Einsatz für Schubkästen mit 500 mm Breite.
For common drawer cabinets of 500 mm width.



50 CM INSET.

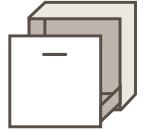

HAILO AS Triple XL 500 18/28.

3631581



Trennung:	2-fach
Abfalleimer:	1 x 28 l, 1 x 18 l, Gesamtvolumen 46 l
Montageart:	Schubkastenmontage, Seitenwandstärke 16 - 19 mm
Schubkasten Nenntiefe:	≥ 420 mm
Deckel:	Metall-Systemdeckel
Farbe:	Metall- und Kunststoffteile dunkelgrau
Produkt-Maße (T x H):	400 x 402 mm
Verpackungsmaße (B x T x H):	445 x 325 x 520 mm
Gewicht mit Verpackung:	8,4 kg

HAILO AS Triple XL 500 18/13/13/D.

3631591



Trennung:	3-fach
Abfalleimer:	1 x 18 l, 2 x 13 l, Gesamtvolumen 44 l 1 x Behälterdeckel 13 l
Montageart:	Schubkastenmontage Seitenwandstärke 16 bis 19 mm
Schubkasten Nenntiefe:	≥ 420 mm
Deckel:	Metall-Systemdeckel
Farbe:	Metall- und Kunststoffteile dunkelgrau
Produkt-Maße (T x H):	400 x 402 mm
Verpackungsmaße (B x T x H):	480 x 660 x 440 mm
Gewicht mit Verpackung:	9,2 kg

HAILO AS XXL 500 12/8,5/8,5/D/P/P.

3630501



Trennung:	3-fach
Abfalleimer:	1 x 12 l, 2 x 8,5 l, Gesamtvolumen 29 l, 2 x Putzmittelkorb 4,1 l, 1x Behälterdeckel 12 l
Montageart:	Schubkastenmontage, Seitenwandstärke 16 bis 19 mm
Schubkasten Nenntiefe:	≥ 500 mm
Deckel:	Metall-Systemdeckel
Farbe:	Metallteile silberfarben, Kunststoffteile grau
Produkt-Maße (T x H):	433 x 330 mm
Verpackungsmaße (B x T x H):	455 x 315 x 475 mm
Gewicht mit Verpackung:	8,5 kg
Nicht für Blum Legra Box F	

Einsatz für Schubkästen mit 500 mm Breite.

For common drawer cabinets of 500 mm width.

Separation: 2-fold
Inner bins: 1 x 28 l, 1 x 18 l, Total capacity 46 l
Type of installation: **inside available drawer,**
 side-wall-thickness 16 - 19 mm
Nominal drawer-depth: ≥ 420 mm
Lid: Sheet metal system Lid
Colour: Metal and plastic parts dark grey
Product dimensions (D x H): 400 x 402 mm
Packing dimensions (W x D x H): 445 x 325 x 520 mm
Weight incl. packing: 8,4 kg



3631581



4 007126 364357

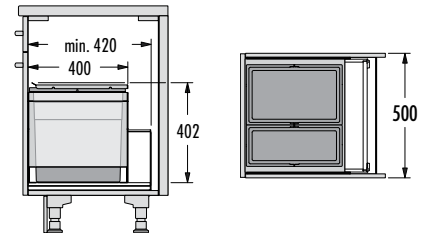

30 cm

40 cm

45 cm

50 cm

Separation: 3-fold
Inner bins: 1 x 18 l, 2 x 13 l, Total capacity 44 l, 1 x Lid 13 l
Type of installation: **inside available drawer,**
 side-wall-thickness 16 - 19 mm
Nominal drawer-depth: ≥ 420 mm
Lid: Sheet metal system Lid
Colour: Metal and plastic parts dark grey
Product dimensions (D x H): 400 x 402 mm
Packing dimensions (W x D x H): 480 x 660 x 440 mm
Weight incl. packing: 9,2 kg



3631591



4 007126 364364

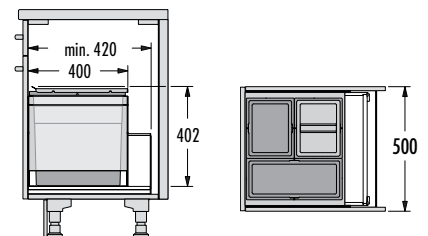

60 cm

80 cm

90 cm

Inch

Separation: 3-fold
Inner bins: 1 x 12 l, 2 x 8.5 l, Total capacity 29 l
 2 x Cleaners basket 4.1 l, 1 x Lid 12 l
Type of installation: **inside available drawer,**
 side-wall-thickness 16 - 19 mm
Nominal drawer-depth : ≥ 500 mm
Lid: Sheet metal system Lid
Colour: Metal parts silver-coloured, plastic parts grey
Product dimensions (D x H): 433 x 330 mm
Packing dimensions (W x D x H): 455 x 315 x 475 mm
Weight incl. packing: 8,5 kg
Not suitable for Blum Legra Box F



3630501



4 007126 305008

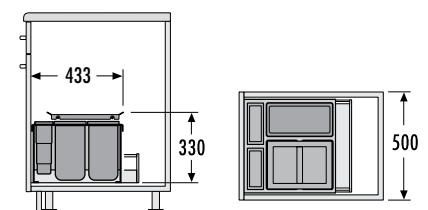

50 CM INSET.

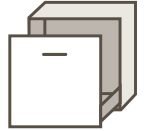

HAILO AS Separato K 500 18/8/8/D.

3620511



Trennung:	3-fach
Abfalleimer:	1 x 18 l, 2 x 8 l, Gesamtvolumen 34 l, 1 x Behälterdeckel 8 l
Montageart:	Schubkastenmontage, Seitenwandstärke 16 bis 19 mm
Schubkasten Nenntiefe	≥ 500 mm
Deckel:	Kunststoff-Deckel herausziehbar, Seitenwandmontage
Farbe:	Kunststoffteile hellgrau
Produktmaße (B x T x H):	457 x 491 x 340 mm
Verpackungsmaße (B x T x H):	510 x 470 x 285 mm
Gewicht mit Verpackung:	4,1 kg
Nicht für Blum Legra Box F	

HAILO AS Separato K 500 18/8/8/D dunkelgrau.

3620521



Trennung:	3-fach
Abfalleimer:	1 x 18 l, 2 x 8 l, Gesamtvolumen 34 l, 1 x Behälterdeckel 8 l
Montageart:	Schubkastenmontage, Seitenwandstärke 16 bis 19 mm
Schubkasten Nenntiefe	≥ 500 mm
Deckel:	Kunststoff-Deckel herausziehbar, Seitenwandmontage
Farbe:	Kunststoffteile dunkelgrau
Produktmaße (B x T x H):	457 x 491 x 340 mm
Verpackungsmaße (B x T x H):	510 x 470 x 285 mm
Gewicht mit Verpackung:	4,1 kg
Nicht für Blum Legra Box F	

Einsatz für Schubkästen mit 500 mm Breite.

For common drawer cabinets of 500 mm width.

Separation: 3-fold
Inner bins: 1 x 18 l, 2 x 8 l Total capacity 34 l, 1 x Lid 8 l
Type of installation: **inside available drawer,**
 side-wall-thickness 16 - 19 mm

Nominal drawer-depth ≥ 500 mm
Lid: Plastic-lid single extension, sidewall-mounted
Colour: Plastic parts light-grey
Product dimensions (W x D x H): 457 x 491 x 340 mm
Packing dimensions (W x D x H): 510 x 470 x 285 mm
Weight incl. packing: 4,1kg
 Not suitable for Blum Legra Box F



3620511



4 007126 362056

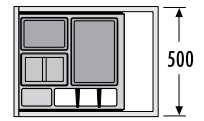
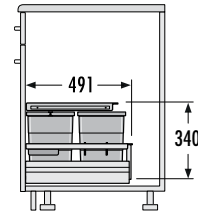

30 cm

40 cm

45 cm

50 cm

Separation: 3-fold
Inner bins: 1 x 18 l, 2 x 8 l Total capacity 34 l, 1 x Lid 8 l
Type of installation: **inside available drawer,**
 side-wall-thickness 16 - 19 mm

Nominal drawer-depth ≥ 500 mm
Lid: Plastic-lid single extension, sidewall-mounted
Colour: Plastic parts dark-grey
Product dimensions (W x D x H): 457 x 491 x 340 mm
Packing dimensions (W x D x H): 510 x 470 x 285 mm
Weight incl. packing: 4,1kg
 Not suitable for Blum Legra Box F



3620521



4 007126 305909

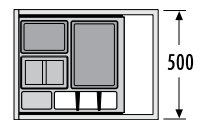
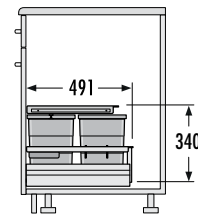

60 cm

80 cm

90 cm

Inch



SWING

Übrigens, wussten Sie, ...

By the way, did you know ...

*... dass HAILO bereits in der Gründungszeit 1947
Abfallsammler produzierte?*

*... that HAILO has been producing waste bins right from
the outset, early 1947?*

60 CM



Für Schränke ab 600 mm Breite mit Drehtür.
For hinged door cabinets from 600 mm width.



30 cm

40 cm

45 cm

50 cm

60 cm

80 cm

90 cm

Inch

60 CM SWING.

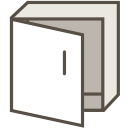

HAILO AS Raumspar Tandem S plus 18/12.

3644801



Trennung:	2-fach
Abfalleimer:	1 x 18 l, 1 x 12 l, Gesamtvolumen 30 l
Montageart:	Bodenmontage
Auszugsschienen:	Vollauszug mit Ausfahrautomatik
Deckel:	Metallsystemdeckel, Seitenwandmontage
Farbe:	Metallteile silberfarben, Kunststoffteile hellgrau
Produktmaße (B x T x H):	556 x 367 x 376 mm
Verpackungsmaße (B x T x H):	580 x 400 x 360 mm
Gewicht mit Verpackung:	8,5 kg

HAILO AS Raumspar Tandem S plus 12/8/8/D.

3644831



Trennung:	3-fach
Abfalleimer:	1 x 12 l, 2 x 8 l, Gesamtvolumen 28 l, 1 x Behälterdeckel 8 l
Montageart:	Bodenmontage
Auszugsschienen:	Vollauszug mit Ausfahrautomatik
Deckel:	Metallsystemdeckel, Seitenwandmontage
Farbe:	Metallteile silberfarben, Kunststoffteile hellgrau
Produktmaße (B x T x H):	556 x 367 x 376 mm
Verpackungsmaße (B x T x H):	580 x 400 x 360 mm
Gewicht mit Verpackung:	8,1 kg

HAILO AS Raumspar Tandem S plus 18/12.

3644821



Trennung:	2-fach
Abfalleimer:	1 x 18 l, 1 x 12 l, Gesamtvolumen 30 l
Montageart:	Bodenmontage
Auszugsschienen:	Vollauszug mit Ausfahrautomatik
Farbe:	Metallteile silberfarben, Kunststoffteile hellgrau
Produktmaße (B x T x H):	432 x 338 x 360 mm
Verpackungsmaße (B x T x H):	490 x 360 x 360 mm
Gewicht mit Verpackung:	8,5 kg
Praktische Ablagemulde im Kunststoff-Deckel integriert (Seitenwandunabhängig)	

Für Schränke ab 600 mm Breite mit Drehtür.

For hinged door cabinets from 600 mm width.

Separation: 2-fold
 Inner bins: 1 x 18 l, 1 x 12 l, Total capacity 30 l
Type of installation: **bottom-mounted**
 Slides: full extension with automatic door-follower
 Lid: Sheet metal system Lid, sidewall-mounted
 Colour: Metal parts silver-coloured, Plastic parts light grey
 Product dimensions (W x D x H): 556 x 367 x 376 mm
 Packing dimensions (W x D x H): 580 x 400 x 360 mm
 Weight incl. packing: 8,5 kg



3644801



4 007126 364562

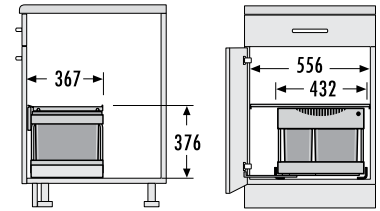

30 cm

40 cm

45 cm

50 cm

60 cm

Separation: 3-fold
 Inner bins: 1 x 12 l, 2 x 8 l, Total capacity 28 l, 1x Lid 8 l
Type of installation: **bottom-mounted,**
in single-door-cabinet
 Slides: full extension with automatic door-follower
 Lid: Sheet metal system Lid, sidewall-mounted
 Colour: Metal parts silver-coloured, Plastic parts light grey
 Product dimensions (W x D x H): 556 x 367 x 376 mm
 Packing dimensions (W x D x H): 580 x 400 x 360 mm
 Weight incl. packing: 8,1 kg



3644831



4 007126 364586

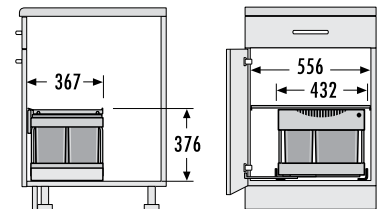

80 cm

90 cm

Inch

Separation: 2-fold
 Inner bins: 1 x 18 l, 1 x 12 l, Total capacity 30 l
Type of installation: **bottom-mounted**
 Slides: full extension with automatic door-follower
 Colour: Metal parts silver-coloured, Plastic parts light-grey
 Product dimensions (W x D x H): 432 x 338 x 360 mm
 Packing dimensions (W x D x H): 490 x 360 x 360 mm
 Weight incl. packing: 8,5 kg
 Practical storage area integrated in the plastic-lid
 (fixed on frame, independent of sidewall)



3644821



4 007126 364579

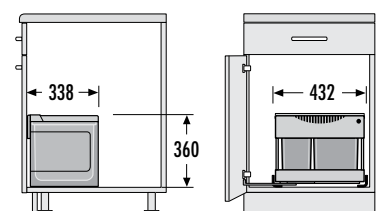



Übrigens, wussten Sie, ...

By the way, did you know ...

... dass HAILO für die meisten Produkte eine Montageanleitung auf der Website zur Verfügung stellt?

... that HAILO installation instructions for most products are available on the website?

60 CM



Für Schränke mit 600 mm Breite mit Frontauszug.

For cabinets with front-mount-door of 600 mm width.



60 CM SLIDE.



HAILO AS Cargo Synchro 600 28/28.

3608621



Trennung:	2-fach
Abfalleimer:	2 x 28 l, Gesamtvolumen 56 l
Montageart:	Seitenwandmontage, selbstjustierend 16 - 19 mm
Auszugsschienen:	abgedeckter, gedämpfter Selbsteinzug mit synchronisiertem Überauszug
Systemtiefe:	400 mm
Deckel:	Herausfahrbarer Metallsystemdeckel/Kunststoff, vollflächig belegt mit rutschfester Gummimatte
Farbe:	Metall- und Kunststoffteile dunkelgrau
Produktmaße (B x T x H):	562-568 x 400 x 424 mm
Verpackungsmaße (B x T x H):	575 x 340 x 480 mm
Gewicht mit Verpackung:	11,8 kg

HAILO AS Cargo Synchro 600 28/13/13/D.

3608631



Trennung:	3-fach
Abfalleimer:	1 x 28 l, 2 x 13 l, Gesamtvolumen 54 l, 1 x Behälterdeckel 13 l
Montageart:	Seitenwandmontage, selbstjustierend 16 - 19 mm
Auszugsschienen:	abgedeckter, gedämpfter Selbsteinzug mit synchronisiertem Überauszug
Systemtiefe:	400 mm
Deckel:	Herausfahrbarer Metallsystemdeckel/Kunststoff, vollflächig belegt mit rutschfester Gummimatte
Farbe:	Metall- und Kunststoffteile dunkelgrau
Produktmaße (B x T x H):	562-568 x 400 x 424 mm
Verpackungsmaße (B x T x H):	575 x 340 x 480 mm
Gewicht mit Verpackung:	12,1 kg

HAILO AS Euro Cargo 600 38/38/12/D/2,5 dunkelgrau.

3619771



Trennung:	4-fach
Abfalleimer:	2 x 38 l, 1 x 12 l, 1 x 2,5 l, Gesamtvolumen 91 l, 1 x Behälterdeckel 12 l
Montageart:	Seitenwandmontage, selbstjustierend 16 - 19 mm
Auszugsschienen:	abgedeckter, gedämpfter Selbsteinzug mit synchronisiertem Überauszug
Systemtiefe:	528 mm
Deckel:	Metallsystemdeckel
Farbe:	Metall- und Kunststoffteile dunkelgrau
Produktmaße (B x T x H):	562- 568 x 528 x 545 mm
Verpackungsmaße (B x T x H):	590 x 325 x 620 mm
Gewicht mit Verpackung:	15,5 kg

Für Schränke mit 600 mm Breite mit Frontauszug.

For cabinets with front-mount-door of 600 mm width.

Separation: 2-fold
Inner bins: 2 x 28 l, Total capacity 56 l
Type of installation: side-wall-mounted, self-adjusting to 16 - 19 mm side walls
Slides: covered, dampened slides with self-closing device with fully synchronized over-travel
System-depth: 400 mm
Lid: Pullout metal/plastic system lid, with anti-slip rubber mat
Colour: Metal and plastic parts dark grey
Product dimensions (W x D x H): 562-568 x 400 x 424 mm
Packing dimensions (W x D x H): 575 x 340 x 480 mm
Weight incl. packing: 11,8 kg

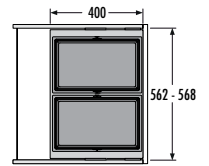
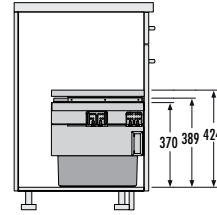

Separation: 3-fold
Inner bins: 1 x 28 l, 2 x 13 l, Total capacity 54 l, 1 x Lid 13 l
Type of installation: side-wall-mounted, self-adjusting to 16 - 19 mm side walls
Slides: covered, dampened slides with self-closing device with fully synchronized over-travel
System-depth: 400 mm
Lid: Pullout metal/ plastic system lid, with anti-slip rubber mat
Colour: Metal and plastic parts dark grey
Product dimensions (W x D x H): 562-568 x 400 x 424 mm
Packing dimensions (W x D x H): 575 x 340 x 480 mm
Weight incl. packing: 12,1 kg

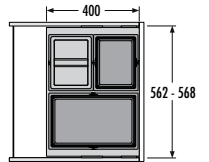
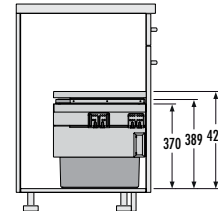

Separation: 4-fold
Inner bins: 2 x 38 l, 1 x 12 l, 1 x 2.5 l, Total capacity 91 l, 1 x Lid 12 l
Type of installation: side-wall-mounted, self-adjusting to 16 - 19 mm side walls
Slides: covered, dampened slides with self-closing device with fully synchronized over-travel
System-depth: 528 mm
Lid: Sheet metal system Lid
Colour: Metal and plastic parts dark grey
Product dimensions (W x D x H): 562- 568 x 528 x 545 mm
Packing dimensions (W x D x H): 590 x 325 x 620 mm
Weight incl. packing: 15,5 kg

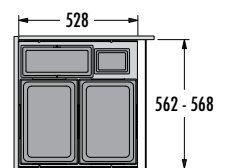
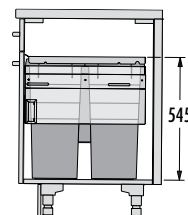

30 cm

40 cm

45 cm

50 cm

60 cm

80 cm

90 cm

Inch

60 CM SLIDE.

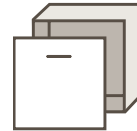

HAILO AS Euro Cargo 600 38/38/12/D/2,5.

3619621



Trennung:	4-fach
Abfalleimer:	2 x 38 l, 1 x 12 l, 1 x 2,5 l, Gesamtvolumen 91 l, 1 x Behälterdeckel 12 l
Montageart:	Seitenwandmontage, selbstjustierend 16 - 19 mm
Auszugsschienen:	abgedeckter, gedämpfter Selbsteinzug mit synchronisiertem Überauszug
Systemtiefe:	528 mm
Deckel:	Metallsystemdeckel
Farbe:	Metallteile silberfarben, Kunststoffteile hellgrau
Produktmaße (B x T x H):	562- 568 x 528 x 545 mm
Verpackungsmaße (B x T x H):	590 x 325 x 620 mm
Gewicht mit Verpackung:	15,5 kg

HAILO AS Cargo 600 28/28.

3610841



Trennung:	2-fach
Abfalleimer:	2 x 28 l, Gesamtvolumen 56 l
Montageart:	Seitenwandmontage, selbstjustierend 16 - 19 mm
Auszugsschienen:	abgedeckter, gedämpfter Selbsteinzug mit synchronisiertem Überauszug
Systemtiefe:	448 mm
Deckel:	Metallsystemdeckel
Farbe:	Metall- und Kunststoffteile dunkelgrau
Produktmaße (B x T x H):	562-568 x 434 x 370 mm
Verpackungsmaße (B x T x H):	480 x 310 x 610 mm
Gewicht mit Verpackung:	11,4 kg

HAILO AS Cargo 600 28/13/13/D.

3610851



Trennung:	3-fach
Abfalleimer:	1 x 28 l, 2 x 13 l, Gesamtvolumen 54 l, 1 Behälterdeckel 13 l
Montageart:	Seitenwandmontage, selbstjustierend 16 - 19 mm
Auszugsschienen:	abgedeckter, gedämpfter Selbsteinzug mit synchronisiertem Überauszug
Systemtiefe:	448 mm
Deckel:	Metallsystemdeckel
Farbe:	Metall- und Kunststoffteile dunkelgrau
Produktmaße (B x T x H):	562-568 x 434 x 370 mm
Verpackungsmaße (B x T x H):	480 x 310 x 610 mm
Gewicht mit Verpackung:	11,8 kg

Für Schränke mit 600 mm Breite mit Frontauszug.

For cabinets with front-mount-door of 600 mm width.

Separation: 4-fold
Inner bins: 2 x 38 l, 1 x 12 l, 1 x 2.5 l, Total capacity 91 l, 1 x Lid 12 l
Type of installation: side-wall-mounted, self-adjusting to 16 - 19 mm side walls
Slides: covered, dampened slides with self-closing device with fully synchronized over-travel
System-depth: 528 mm
Lid: Sheet metal system Lid
Colour: Metal parts silver-coloured, Plastic parts light-grey
Product dimensions (W x D x H): 562-568 x 528 x 545 mm
Packing dimensions (W x D x H): 590 x 325 x 620 mm
Weight incl. packing: 15,5 kg

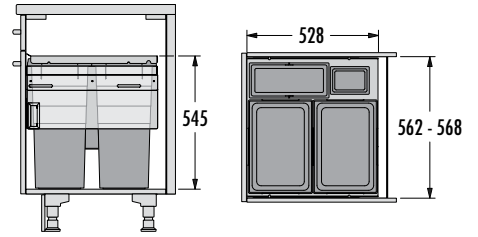

Separation: 2-fold
Inner bins: 2 x 28 l, Total capacity 56 l
Type of installation: side-wall-mounted, self-adjusting to 16 - 19 mm side walls
Slides: covered, dampened slides with self-closing device with fully synchronized over-travel
System-depth: 448 mm
Lid: Sheet metal system Lid
Colour: Metal and plastic parts dark grey
Product dimensions (W x D x H): 562-568 x 434 x 370 mm
Packing dimensions (W x D x H): 480 x 310 x 610 mm
Weight incl. packing: 11,4 kg

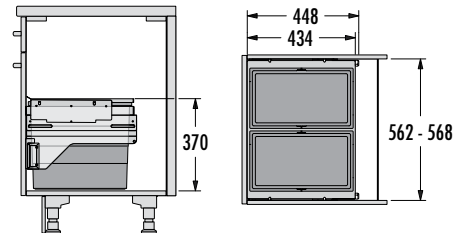

Separation: 3-fold
Inner bins: 1 x 28 l, 2 x 13 l, Total capacity 54 l, 1 x Lid 13 l
Type of installation: side-wall-mounted, self-adjusting to 16 - 19 mm side walls
Slides: covered, dampened slides with self-closing device with fully synchronized over-travel
System-depth: 448 mm
Lid: Sheet metal system Lid
Colour: Metal and plastic parts dark grey
Product dimensions (W x D x H): 562-568 x 434 x 370 mm
Packing dimensions (W x D x H): 480 x 310 x 610 mm
Weight incl. packing: 11,8 kg

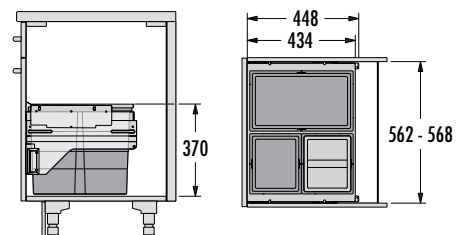

30 cm

40 cm

45 cm

50 cm

60 cm

80 cm

90 cm

Inch

60 CM SLIDE.

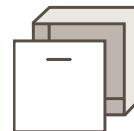

HAILO AS Cargo 600 13/13/13/13/D.

3610861



Trennung:	4-fach
Abfalleimer:	4 x 13 l, Gesamtvolumen 52 l, 1 Behälterdeckel 13 l
Montageart:	Seitenwandmontage, selbstjustierend 16 - 19 mm
Auszugsschienen:	abgedeckter, gedämpfter Selbsteinzug mit synchronisiertem Überauszug
Systemtiefe:	448 mm
Deckel:	Metallsystemdeckel
Farbe:	Metall- und Kunststoffteile dunkelgrau
Produktmaße (B x T x H):	562-568 x 434 x 370 mm
Verpackungsmaße (B x T x H):	480 x 310 x 610 mm
Gewicht mit Verpackung:	11,7 kg

HAILO AS Euro Cargo S 600 30/30.

3610621



Trennung:	2-fach
Abfalleimer:	2 x 30 l, Gesamtvolumen 60 l
Montageart:	Seitenwandmontage, selbstjustierend 16 - 19 mm
Auszugsschienen:	abgedeckter, gedämpfter Selbsteinzug mit synchronisiertem Überauszug
Systemtiefe:	448 mm
Deckel:	Metallsystemdeckel
Farbe:	Metallteile silberfarben, Kunststoffteile hellgrau
Produktmaße (B x T x H):	562- 568 x 403 x 439 mm
Verpackungsmaße (B x T x H):	490 x 320 x 620 mm
Gewicht mit Verpackung:	11,45 kg

HAILO AS Euro Cargo S 600 30/13/13/D.

3610631



Trennung:	3-fach
Abfalleimer:	1 x 30 l, 2 x 13 l, Gesamtvolumen 56 l, 1 x Behälterdeckel 13 l
Montageart:	Seitenwandmontage, selbstjustierend 16 - 19 mm
Auszugsschienen:	abgedeckter, gedämpfter Selbsteinzug mit synchronisiertem Überauszug
Systemtiefe:	448 mm
Deckel:	Metallsystemdeckel
Farbe:	Metallteile silberfarben, Kunststoffteile hellgrau
Produktmaße (B x T x H):	562- 568 x 403 x 439 mm
Verpackungsmaße (B x T x H):	490 x 320 x 620 mm
Gewicht mit Verpackung:	11,45 kg

Für Schränke mit 600 mm Breite mit Frontauszug.

For cabinets with front-mount-door of 600 mm width.

Separation: 4-fold
Inner bins: 4 x 13 l, Total capacity 52 l, 1 x Lid 13 l
Type of installation: side-wall-mounted, self-adjusting to 16 - 19 mm side walls
Slides: covered, dampened slides with self-closing device with fully synchronized over-travel
System-depth: 448 mm
Lid: Sheet metal system Lid
Colour: Metal and plastic parts dark grey
Product dimensions (W x D x H): 562-568 x 434 x 370 mm
Packing dimensions (W x D x H): 480 x 310 x 610 mm
Weight incl. packing: 11,7 kg

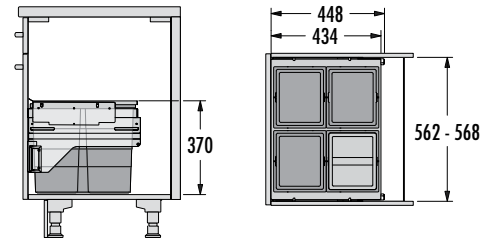

Separation: 2-fold
Inner bins: 2 x 30 l, Total capacity 60 l
Type of installation: side-wall-mounted, self-adjusting to 16 - 19 mm side walls
Slides: covered, dampened slides with self-closing device with fully synchronized over-travel
System-depth: 448 mm
Lid: Sheet metal system Lid
Colour: Metal parts silver-coloured, plastic parts light grey
Product dimensions (W x D x H): 562- 568 x 403 x 439 mm
Packing dimensions (W x D x H): 490 x 320 x 620 mm
Weight incl. packing: 11,45 kg

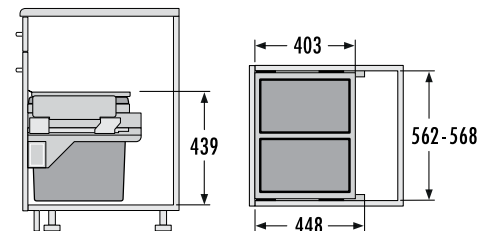

Separation: 3-fold
Inner bins: 1 x 30 l, 2 x 13 l, Total capacity 56 l, 1 x Lid 13 l
Type of installation: side-wall-mounted, self-adjusting to 16 - 19 mm side walls
Slides: covered, dampened slides with self-closing device with fully synchronized over-travel
System-depth: 448 mm
Lid: Sheet metal system Lid
Colour: Metal parts silver-coloured, plastic parts light grey
Product dimensions (W x D x H): 562- 568 x 403 x 439 mm
Packing dimensions (W x D x H): 490 x 320 x 620 mm
Weight incl. packing: 11,45 kg

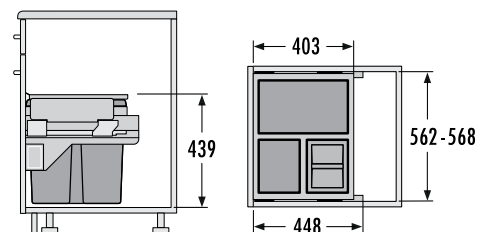

30 cm

40 cm

45 cm

50 cm

60 cm

80 cm

90 cm

Inch

60 CM SLIDE.

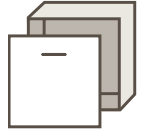

HAILO AS Cargo Soft short 600 20/10/10/D.



3610681

Trennung:	3-fach
Abfalleimer:	1 x 20 l, 2 x 10 l, Gesamtvolumen 40 l, 1 x Behälterdeckel 10 l
Montageart:	Seitenwandmontage, selbstjustierend 16 - 19 mm
Auszugsschienen:	abgedeckter, gedämpfter Selbsteinzug
Systemtiefe:	448 mm
Deckel:	Metallsystemdeckel
Farbe:	Metallteile silberfarben, Kunststoffteile hellgrau
Produktmaße (B x T x H):	562- 568 x 332 x 370 mm
Verpackungsmaße (B x T x H):	490 x 320 x 620 mm
Gewicht mit Verpackung:	12,2 kg

HAILO AS Cargo Aqua 600 13/13/D.



3608601

Der HAILO Cargo Aqua ist ein Abfalltrennsystem für Frontauszugsschränke/Spülenunterschranke, in denen seitlich ein Wasseraufbereiter integriert werden soll.

Trennung:	2-fach
Abfalleimer:	2 x 13 l, Gesamtvolumen 26 l, 1 Behälterdeckel 13 l
Montageart:	Seitenwandmontage, selbstjustierend 16 - 19 mm
Auszugsschienen:	abgedeckter, gedämpfter Selbsteinzug mit synchronisiertem Überauszug
Systemtiefe:	400 mm
Farbe:	Metall- und Kunststoffteile dunkelgrau
Produktmaße (B x T x H):	352 x 400 x 411 mm
Verpackungsmaße (B x T x H):	475 x 395 x 450 mm
Gewicht mit Verpackung:	12,5 kg
Rechts und links im Schrank verwendbar / Platz für Wasseraufbereiter: 210 mm	

HAILO AS Cargo Aqua 600 28.



3608611

Der HAILO Cargo Aqua ist ein Abfalltrennsystem für Frontauszugsschränke/Spülenunterschranke, in denen seitlich ein Wasseraufbereiter integriert werden soll.

Abfalleimer:	1 x 28 l
Montageart:	Seitenwandmontage, selbstjustierend 16 - 19 mm
Auszugsschienen:	abgedeckter, gedämpfter Selbsteinzug mit synchronisiertem Überauszug
Systemtiefe:	400 mm
Farbe:	Metall- und Kunststoffteile dunkelgrau
Produktmaße (B x T x H):	352 x 400 x 411 mm
Verpackungsmaße (B x T x H):	475 x 395 x 450 mm
Gewicht mit Verpackung:	12,5 kg
Rechts und links im Schrank verwendbar / Platz für Wasseraufbereiter: 210 mm	

Für Schränke mit 600 mm Breite mit Frontauszug.

For cabinets with front-mount-door of 600 mm width.

Separation: 3-fold
Inner bins: 1 x 20 l, 2 x 10 l, Total capacity 40 l, 1 x Lid 10 l
Type of installation: side-wall-mounted, self-adjusting
 to 16 - 19 mm side walls mounts also under sink
Slides: covered, dampened slides with self-closing device
System-depth: 448 mm
Lid: Sheet metal system Lid
Colour: Metal parts silver-coloured, plastic parts light grey
Product dimensions (W x D x H): 562- 568 x 332 x 370 mm
Packing dimensions (W x D x H): 490 x 320 x 620 mm
Weight incl. packing: 12,2 kg

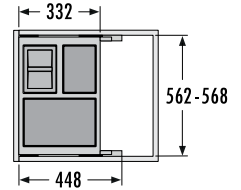
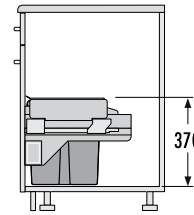

The HAILO Cargo Aqua is a waste separation system for front-mount-door cabinets/sink base units in which a water purifier is to be integrated at the side.

Separation: 2-fold
Inner bins: 2 x 13 l, Total capacity 26 l, 1 x Lid 13 l
Type of installation: side-wall-mounted, self-adjusting to 16 - 19 mm side walls mounts
Slides: covered, dampened slides with self-closing device
 with fully synchronized over-travel
System-depth: 400 mm
Colour: Metal and plastic parts dark grey
Product dimensions (W x D x H): 352 x 400 x 411 mm
Packing dimensions (W x D x H): 475 x 395 x 450 mm
Weight incl. packing: 12,5 kg
 Can be used on the right and left in the cabinet / Space for water purifier: 210 mm

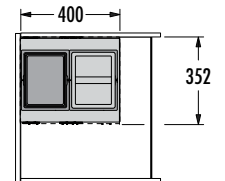
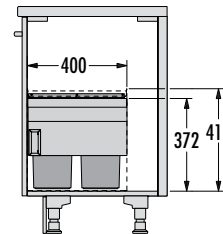

The HAILO Cargo Aqua is a waste separation system for front-mount-door cabinets/sink base units in which a water purifier is to be integrated at the side.

Inner bins: 1 x 28 l
Type of installation: side-wall-mounted, self-adjusting to 16 - 19 mm side walls mounts
Slides: covered, dampened slides with self-closing device
 with fully synchronized over-travel
System-depth: 400 mm
Colour: Metal and plastic parts dark grey
Product dimensions (W x D x H): 352 x 400 x 411 mm
Packing dimensions (W x D x H): 475 x 395 x 450 mm
Weight incl. packing: 12,5 kg
 Can be used on the right and left in the cabinet / Space for water purifier: 210 mm

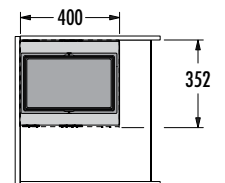
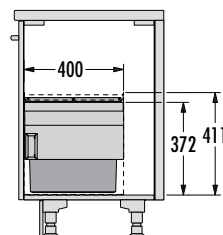

30 cm

40 cm

45 cm

50 cm

60 cm

80 cm

90 cm

Inch

60 CM SLIDE.

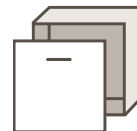

HAILO Kick and Go.

3691301

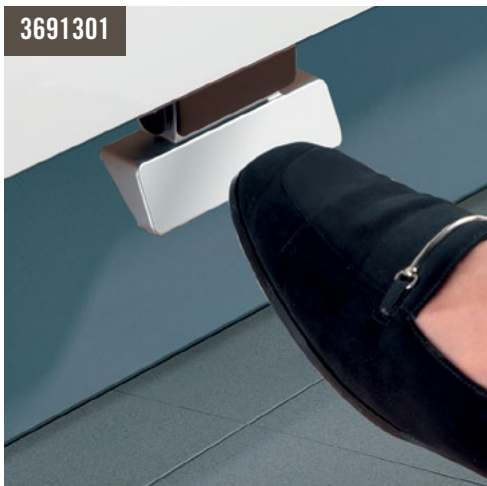

Fußhebel

"Kick and go" für Frontauszüge
und untere Schubkästen

siehe Seite 212

HAILO Libero 3.0.

3697301



Elektronischer Türöffner

HAILO Libero – Hands Free Opener

Der Laser-Sensoröffner von HAILO für ein automatisches,
komfortables Öffnen aller Abfalltrennsysteme mit
Frontanbindung und aller Auszugssysteme.

Einfache Bedienung durch Fußsensor und / oder
Sprachsteuerung.

Ausführliche Beschreibung Seite 210

Für Schränke mit Frontauszug.

For cabinets with front-mount-door.

Foot Pedal

"Kick and go" for Front mounted door and lower drawer

More information: page 212



3691301



4 007126 369123

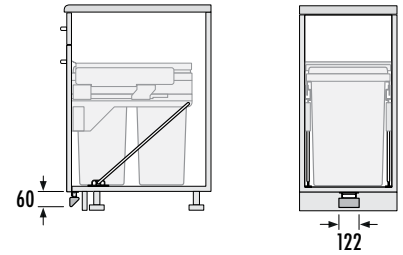

30 cm

40 cm

45 cm

50 cm

60 cm

Electronic Door Opener

HAILO „Liberio“ – Hands Free Opener

HAILO's electronic sensor-opener Liberio 3.0 for front-mount-doors and drawers offers an automatic, comfortable hands-free opening of all waste-recycling-systems with attached door-panel, and of any common, also damped, drawer-mounted systems. Easy operation by laser-sensor and / or optionally voice activated.

More information: page 210



3697301



4 007126 301000

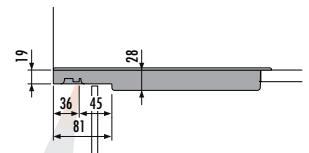
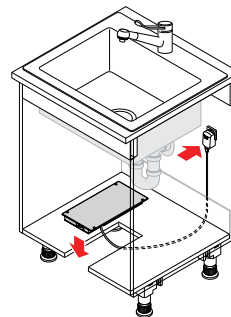

80 cm

90 cm

Inch

**H
E
S
N**



Übrigens, wussten Sie, ...

By the way, did you know ...

... dass die Marke HAILO in Deutschland einen Bekanntheitsgrad von 68 % besitzt?

... that the HAILO brand enjoys a recognition factor of approx. 68 % in Germany?

60 CM



Einsatz für Schubkästen mit 600 mm Breite.
For common drawer cabinets of 600 mm width.



30 cm

40 cm

45 cm

50 cm

60 cm

80 cm

90 cm

Inch

60 CM INSET.

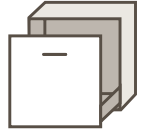

HAILO AS Triple XL 600 28/28.

3631681



Trennung:	2-fach
Abfalleimer:	2 x 28 l, Gesamtvolumen 56 l,
Montageart:	Schubkastenmontage, Seitenwandstärke 16 - 19 mm
Schubkasten Nenntiefe:	≥ 420 mm
Deckel:	Metall-Systemdeckel
Farbe:	Metall- und Kunststoffteile dunkelgrau
Produkt-Maße (T x H):	400 x 402 mm
Verpackungsmaße (B x T x H):	425 x 305 x 565 mm
Gewicht mit Verpackung:	9,4 kg

HAILO AS Triple XL 600 28/13/13/D.

3631691



Trennung:	3-fach
Abfalleimer:	1 x 28 l + 2 x 13 l, Gesamtvolumen 54 l, 1 x Behälterdeckel 13 l
Montageart:	Schubkastenmontage, Seitenwandstärke 16 bis 19 mm
Schubkasten Nenntiefe:	≥ 420 mm
Deckel:	Metall-Systemdeckel
Farbe:	Metall- und Kunststoffteile dunkelgrau
Produkt-Maße (T x H):	400 x 402 mm
Verpackungsmaße (B x T x H):	425 x 305 x 565 mm
Gewicht mit Verpackung:	9,8 kg

HAILO AS XXL 600 18/D/8,5/8,5/P/P.

3630601



Trennung:	3-fach
Abfalleimer:	1 x 18 l, 2 x 8,5 l, Gesamtvolumen 35 l, 1x Behälterdeckel 18 l, 2 x Putzmittelkorb 4,1 l
Montageart:	Schubkastenmontage, Seitenwandstärke 16 bis 19 mm
Schubkasten Nenntiefe:	≥ 500 mm
Deckel:	Metall-Systemdeckel
Farbe:	Metallteile silberfarben, Kunststoffteile grau
Produkt-Maße (T x H):	433 x 330 mm
Verpackungsmaße (B x T x H):	455 x 315 x 580 mm
Gewicht mit Verpackung:	9,5 kg
Nicht für Blum Legra Box F	

Einsatz für Schubkästen mit 600 mm Breite.

For common drawer cabinets of 600 mm width.

Separation: 2-fold
 Inner bins: 2 x 28 l, Total capacity 56 l
Type of installation: **inside available drawer,**
 side-wall-thickness 16 - 19 mm
 Nominal drawer-depth: ≥ 420 mm
 Lid: Sheet metal system Lid
 Colour: Metal and plastic parts dark grey
 Product dimensions (D x H): 400 x 402 mm
 Packing dimensions (W x D x H): 425 x 305 x 565 mm
 Weight incl. packing: 9,4 kg



3631681

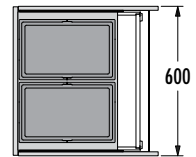
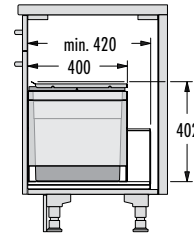

Separation: 3-fold
 Inner bins: 1 x 28 l + 2 x 13 l, Total capacity 54 l, 1 x Lid 13 l
Type of installation: **inside available drawer,**
 side-wall-thickness 16 - 19 mm
 Nominal drawer-depth: ≥ 420 mm
 Lid: Sheet metal system Lid
 Colour: Metal and plastic parts dark grey
 Product dimensions (D x H): 400 x 402 mm
 Packing dimensions (W x D x H): 425 x 305 x 565 mm
 Weight incl. packing: 9,8 kg



3631691

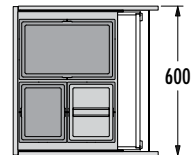
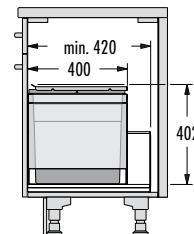

Separation: 3-fold
 Inner bins: 1 x 18 l, 2 x 8.5 l, Total capacity 35 l,
 1 x Lid 18 l, 2 x Cleansers basket 4.1 l
Type of installation: **inside available drawer,**
 side-wall-thickness 16 - 19 mm
 Nominal drawer-depth: ≥ 500 mm
 Lid: Sheet metal system Lid
 Colour: Metal parts silver-coloured, plastic parts grey
 Product dimensions (D x H): 433 x 330 mm
 Packing dimensions (W x D x H): 455 x 315 x 580 mm
 Weight incl. packing: 9,5 kg
 Not suitable for Blum Legra Box F



3630601

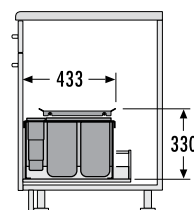

30 cm

40 cm

45 cm

50 cm

60 cm

80 cm

90 cm

Inch

60 CM INSET.



HAILO AS Separato K 600 18/8/8/D.

3620611



Trennung:	3-fach
Abfalleimer:	1 x 18 l, 2 x 8 l, Gesamtvolumen 34 l, 1 x Behälterdeckel 8 l
Montageart:	Schubkastenmontage, Seitenwandstärke 16 bis 19 mm
Schubkasten Nenntiefe:	≥ 500 mm
Deckel:	Kunststoff-Deckel herausziehbar, Seitenwandmontage
Farbe:	Kunststoffteile hellgrau
Produktmaße (B x T x H):	557 x 491 x 340 mm
Verpackungsmaße (B x T x H):	570 x 510 x 275 mm
Gewicht mit Verpackung:	4,7 kg
Nicht für Blum Legra Box F	

HAILO AS Separato K 600 18/8/8/D dunkelgrau.

3620651



Trennung:	3-fach
Abfalleimer:	1 x 18 l, 2 x 8 l, Gesamtvolumen 34 l, 1 x Behälterdeckel 8 l
Montageart:	Schubkastenmontage, Seitenwandstärke 16 bis 19 mm
Schubkasten Nenntiefe:	≥ 500 mm
Deckel:	Kunststoff-Deckel herausziehbar, Seitenwandmontage
Farbe:	Kunststoffteile dunkelgrau
Produktmaße (B x T x H):	557 x 491 x 340 mm
Verpackungsmaße (B x T x H):	570 x 510 x 275 mm
Gewicht mit Verpackung:	4,7 kg
Nicht für Blum Legra Box F	

HAILO AS Separato K 600 20/20.

3620801



Trennung:	2-fach
Abfalleimer:	2 x 20 l, Gesamtvolumen 40 l,
Montageart:	Schubkastenmontage, Seitenwandstärke 16 bis 19 mm
Schubkasten Nenntiefe:	≥ 500 mm
Deckel:	Kunststoff-Deckel herausziehbar, Seitenwandmontage
Farbe:	Kunststoffteile hellgrau
Produktmaße (B x T x H):	557 x 491 x 395 mm
Verpackungsmaße (B x T x H):	570 x 510 x 275 mm
Gewicht mit Verpackung:	5 kg
Nicht für Blum Legra Box F	

Einsatz für Schubkästen mit 600 mm Breite.

For common drawer cabinets of 600 mm width.

Separation: 3-fold
 Inner bins: 1 x 18 l, 2 x 8 l, Total capacity 34 l, 1 x Lid 8 l
Type of installation: **inside available drawer,**
 side-wall-thickness 16 - 19 mm
 Nominal drawer-depth: ≥ 500 mm
 Lid: Plastic-lid single extension, sidewall-mounted
 Colour: Plastic parts light-grey
 Product dimensions (W x D x H): 557 x 491 x 340 mm
 Packing dimensions (W x D x H): 570 x 510 x 275 mm
 Weight incl. packing: 4,7 kg
 Not suitable for Blum Legra Box F



3620611



4 007126 362063

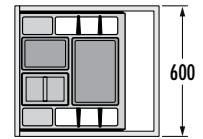
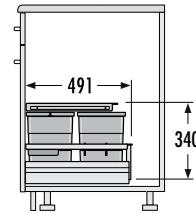

Separation: 3-fold
 Inner bins: 1 x 18 l, 2 x 8 l, Total capacity 34 l, 1 x Lid 8 l
Type of installation: **inside available drawer,**
 side-wall-thickness 16 - 19 mm
 Nominal drawer-depth: ≥ 500 mm
 Lid: Plastic-lid single extension, sidewall-mounted
 Colour: Plastic parts dark-grey
 Product dimensions (W x D x H): 557 x 491 x 340 mm
 Packing dimensions (W x D x H): 570 x 510 x 275 mm
 Weight incl. packing: 4,7 kg
 Not suitable for Blum Legra Box F



3620651



4 007126 305916

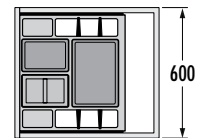
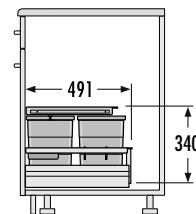

Separation: 2-fold
 Inner bins: 2 x 20 l, Total capacity 40 l
Type of installation: **inside available drawer,**
 side-wall-thickness 16 - 19 mm
 Nominal drawer-depth: ≥ 500 mm
 Lid: Plastic-lid single extension, sidewall-mounted
 Colour: Plastic parts light-grey
 Product dimensions (W x D x H): 557 x 491 x 395 mm
 Packing dimensions (W x D x H): 570 x 510 x 275 mm
 Weight incl. packing: 5 kg
 Not suitable for Blum Legra Box F



3620801



4 007126 305220

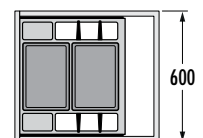
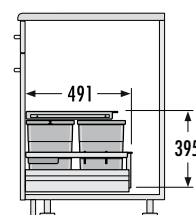

30 cm

40 cm

45 cm

50 cm

60 cm

80 cm

90 cm

Inch

60 CM INSET.



HAILO AS Separato K 600 20/20 dunkelgrau.



3620811

Trennung:	2-fach
Abfalleimer:	2 x 20 l, Gesamtvolumen 40 l,
Montageart:	Schubkastenmontage, Seitenwandstärke 16 bis 19 mm
Schubkasten Nenntiefe:	≥ 500 mm
Deckel:	Kunststoff-Deckel herausziehbar, Seitenwandmontage
Farbe:	Kunststoffteile dunkelgrau
Produktmaße (B x T x H):	557 x 491 x 395 mm
Verpackungsmaße (B x T x H):	570 x 510 x 275 mm
Gewicht mit Verpackung:	4,3 kg
Nicht für Blum Legra Box F	

Einsatz für Schubkästen mit 600 mm Breite.

For common drawer cabinets of 600 mm width.

Separation:	2-fold
Inner bins:	2 x 20 l, Total capacity 40 l
Type of installation:	inside available drawer, side-wall-thickness 16 - 19 mm
Nominal drawer-depth:	≥ 500 mm
Lid:	Plastic-lid single extension, sidewall-mounted
Colour:	Plastic parts dark-grey
Product dimensions (W x D x H):	557 x 491 x 395 mm
Packing dimensions (W x D x H):	570 x 510 x 275 mm
Weight incl. packing:	4,3 kg
Not suitable for Blum Legra Box F	

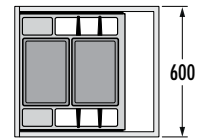
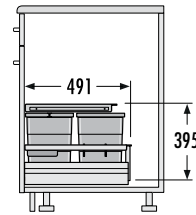

30 cm

40 cm

45 cm

50 cm

60 cm

80 cm

90 cm

Inch

60 CM INSET.

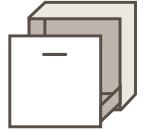

HAILO AS Allegro System:



Flexible Schubkastenlösung zum Einsatz in Küchenschränken.

Das HAILO Allegro System bietet eine hohe Flexibilität für effiziente Abfalltrennung in der Küche. Das System, bestehend aus Anti-Rutsch-Matte und passenden Inneneimern, sowie einem Systemdeckel, passt in nahezu alle Schubladen/ Schubkästen.

Vielfältige Kombinationsmöglichkeiten mit Inneneimern von HAILO sind möglich, um das System an Ihre individuellen Bedürfnisse anzupassen. Passende Systemdeckel sind in Breiten von 450 mm, 500 mm und 600 mm erhältlich und zeichnen sich durch eine Auszugsfunktion sowie praktische Ablagemöglichkeiten aus. Die speziell entwickelte Einlegematte als Basis für die kombinierbaren Inneneimer, bietet mit seiner Noppenstruktur und der Antirutschbeschichtung einen stabilen und sicheren Halt der Inneneimer. Die Noppen fixieren die Eimer zuverlässig, während die Antirutschbeschichtung auf der Unterseite der Matte ein Verrutschen verhindert.

HAILO AS Allegro 220 14/14.

3301611



Trennung:	2-fach
Abfalleimer:	2 x 14 l, Gesamtvolumen 28 l,
Montageart:	Schubkastenmontage,
	Seitenwandstärke 16 bis 19 mm
Schubkasten Nenntiefe:	≥ 500 mm
Deckel:	Kunststoff-Deckel herausziehbar, Seitenwandmontage
Farbe:	Kunststoffteile dunkelgrau
Produktmaße (B x T x H):	476 x 473 x 270 mm
Verpackungsmaße (B x T x H):	575 x 510 x 280 mm
Gewicht mit Verpackung:	3,5 kg
	Mit rutschhemmender Allegro Einlegematte

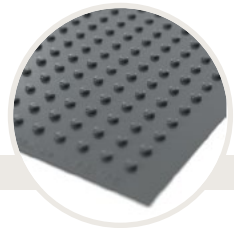

HAILO AS Allegro 220 14/6,5/6,5/D.

3301621



Trennung:	3-fach
Abfalleimer:	1 x 14 l, 2 x 6,5 l Gesamtvolumen 27 l, 1 Behälterdeckel 6,5 l
Montageart:	Schubkastenmontage,
	Seitenwandstärke 16 bis 19 mm
Schubkasten Nenntiefe:	≥ 500 mm
Deckel:	Kunststoff-Deckel herausziehbar, Seitenwandmontage
Farbe:	Kunststoffteile dunkelgrau
Produktmaße (B x T x H):	476 x 473 x 270 mm
Verpackungsmaße (B x T x H):	575 x 510 x 280 mm
Gewicht mit Verpackung:	3,8 kg
	Mit rutschhemmender Allegro Einlegematte



Einsatz für Schubkästen mit 600 mm Breite.

For common drawer cabinets of 600 mm width.

Flexible drawer solution for use in kitchen cabinets.

The HAILO Allegro system offers a high degree of flexibility for efficient waste separation in the kitchen. The system, consisting of an anti-slip mat and matching inner bin, as well as a system lid, fits into almost all drawers.

A wide range of combinations with HAILO inner bins are possible to adapt the system to your individual needs. Matching system lids are available in widths of 450 mm, 500 mm and 600 mm and are characterized by a pull-out function and practical storage options.

The specially developed insert mat as a base for the combinable inner bins, with its nubbed structure and anti-slip coating, provides a stable and secure hold for the inner bins.

The studs reliably hold the buckets in place, while the anti-slip coating on the underside of the mat prevents slipping.

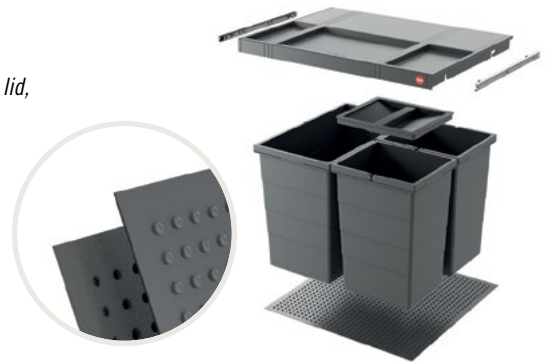

Separation:	2-fold
Inner bins:	2 x 14 l, Total capacity 28 l
Type of installation:	inside available drawer, side-wall-thickness 16 - 19 mm
Nominal drawer-depth:	≥ 500 mm
Lid:	Plastic-lid single extension, sidewall-mounted
Colour:	Plastic parts dark-grey
Product dimensions (W x D x H):	476 x 473 x 270 mm
Packing dimensions (W x D x H):	575 x 510 x 280 mm
Weight incl. packing:	3,5 kg
With anti-slip Allegro mat	

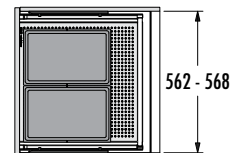
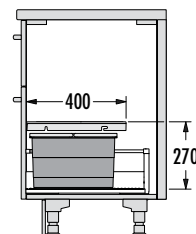

Separation:	3-fold
Inner bins:	1 x 14 l, 2 x 6,5 l, Total capacity 27 l, 1 Lid 6,5 l
Type of installation:	inside available drawer, side-wall-thickness 16 - 19 mm
Nominal drawer-depth:	≥ 500 mm
Lid:	Plastic-lid single extension, sidewall-mounted
Colour:	Plastic parts dark-grey
Product dimensions (W x D x H):	476 x 473 x 270 mm
Packing dimensions (W x D x H):	575 x 510 x 280 mm
Weight incl. packing:	3,8 kg
With anti-slip Allegro mat	

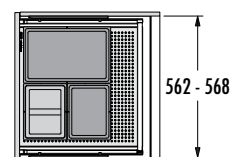
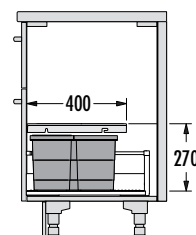

30 cm

40 cm

45 cm

50 cm

60 cm

80 cm

90 cm

Inch

60 CM INSET.

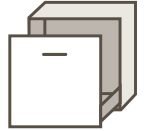

HAILO AS Allegro 295 18/8/8/D.

3301631



Trennung:	3-fach
Abfalleimer:	1 x 18 l, 2 x 8 l, Gesamtvolumen 34 l, 1 Behälterdeckel 8 l
Montageart:	Schubkastenmontage, Seitenwandstärke 16 bis 19 mm
Schubkasten Nenntiefe:	≥ 500 mm
Deckel:	Kunststoff-Deckel herausziehbar, Seitenwandmontage
Farbe:	Kunststoffteile dunkelgrau
Produktmaße (B x T x H):	476 x 473 x 345 mm
Verpackungsmaße (B x T x H):	575 x 510 x 280 mm
Gewicht mit Verpackung:	3,9 kg
	Mit rutschhemmender Allegro Einlegematte



HAILO AS Allegro 295 18/18/8/8/D.

3301641



Trennung:	4-fach
Abfalleimer:	2 x 18 l, 2 x 8 l, Gesamtvolumen 52 l, 1 Behälterdeckel 8 l
Montageart:	Schubkastenmontage, Seitenwandstärke 16 bis 19 mm
Schubkasten Nenntiefe:	≥ 500 mm
Deckel:	Kunststoff-Deckel herausziehbar, Seitenwandmontage
Farbe:	Kunststoffteile dunkelgrau
Produktmaße (B x T x H):	476 x 473 x 345 mm
Verpackungsmaße (B x T x H):	575 x 510 x 280 mm
Gewicht mit Verpackung:	4,6 kg
	Mit rutschhemmender Allegro Einlegematte



HAILO AS Allegro 350 28/28.

3301651



Trennung:	2-fach
Abfalleimer:	2 x 28 l, Gesamtvolumen 56 l
Montageart:	Schubkastenmontage, Seitenwandstärke 16 bis 19 mm
Schubkasten Nenntiefe:	≥ 500 mm
Deckel:	Kunststoff-Deckel herausziehbar, Seitenwandmontage
Farbe:	Kunststoffteile dunkelgrau
Produktmaße (B x T x H):	476 x 473 x 397 mm
Verpackungsmaße (B x T x H):	575 x 510 x 280 mm
Gewicht mit Verpackung:	4 kg
	Mit rutschhemmender Allegro Einlegematte

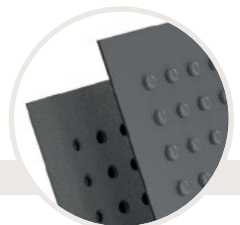

Einsatz für Schubkästen mit 600 mm Breite.

For common drawer cabinets of 600 mm width.

Separation: 3-fold
 Inner bins: 1 x 18 l, 2 x 8 l, Total capacity 34 l, 1 Lid 8 l
Type of installation: **inside available drawer,**
 side-wall-thickness 16 - 19 mm
 Nominal drawer-depth: ≥ 500 mm
 Lid: Plastic-lid single extension, sidewall-mounted
 Colour: Plastic parts dark-grey
 Product dimensions (W x D x H): 476 x 473 x 345 mm
 Packing dimensions (W x D x H): 575 x 510 x 280 mm
 Weight incl. packing: 3,9 kg
 With anti-slip Allegro mat



3301631



4 007126 306203

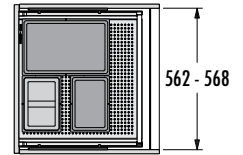
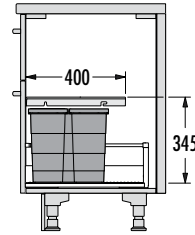

Separation: 4-fold
 Inner bins: 2 x 18 l, 2 x 8 l, Total capacity 52 l, 1 Lid 8 l
Type of installation: **inside available drawer,**
 side-wall-thickness 16 - 19 mm
 Nominal drawer-depth: ≥ 500 mm
 Lid: Plastic-lid single extension, sidewall-mounted
 Colour: Plastic parts dark-grey
 Product dimensions (W x D x H): 476 x 473 x 345 mm
 Packing dimensions (W x D x H): 575 x 510 x 280 mm
 Weight incl. packing: 4,6 kg
 With anti-slip Allegro mat



3301641



4 007126 306210

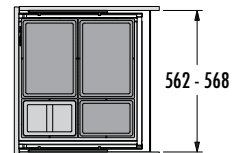
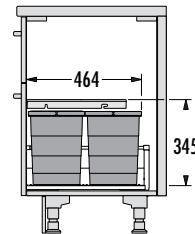

Separation: 2-fold
 Inner bins: 2 x 28 l, Total capacity 56 l
Type of installation: **inside available drawer,**
 side-wall-thickness 16 - 19 mm
 Nominal drawer-depth: ≥ 500 mm
 Lid: Plastic-lid single extension, sidewall-mounted
 Colour: Plastic parts dark-grey
 Product dimensions (W x D x H): 476 x 473 x 397 mm
 Packing dimensions (W x D x H): 575 x 510 x 280 mm
 Weight incl. packing: 4 kg
 With anti-slip Allegro mat



3301651



4 007126 306227

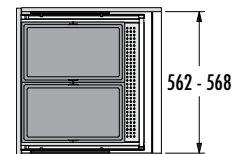
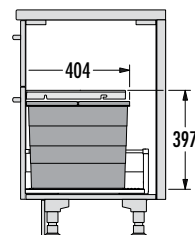

30 cm

40 cm

45 cm

50 cm

60 cm

80 cm

90 cm

Inch

60 CM INSET.

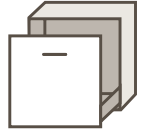

HAILO AS Allegro 350 28/13/13/D.

3301661



Trennung:	3-fach
Abfalleimer:	1 x 28 l, 2 x 13 l, Gesamtvolumen 54 l, 1 Behälterdeckel 13 l
Montageart:	Schubkastenmontage, Seitenwandstärke 16 bis 19 mm
Schubkasten Nenntiefe:	≥ 500 mm
Deckel:	Kunststoff-Deckel herausziehbar, Seitenwandmontage
Farbe:	Kunststoffteile dunkelgrau
Produktmaße (B x T x H):	476 x 473 x 397 mm
Verpackungsmaße (B x T x H):	575 x 510 x 280 mm
Gewicht mit Verpackung:	4,5 kg
	Mit rutschhemmender Allegro Einlegematte



HAILO AS Allegro 380 28/28.

3301671



Trennung:	2-fach
Abfalleimer:	2 x 28 l, Gesamtvolumen 56 l
Montageart:	Schubkastenmontage, Seitenwandstärke 16 bis 19 mm
Schubkasten Nenntiefe:	≥ 500 mm
Deckel:	Kunststoff-Deckel herausziehbar, Seitenwandmontage
Farbe:	Kunststoffteile dunkelgrau
Produktmaße (B x T x H):	476 x 473 x 430 mm
Verpackungsmaße (B x T x H):	575 x 510 x 280 mm
Gewicht mit Verpackung:	4,4 kg
	Mit rutschhemmender Allegro Einlegematte

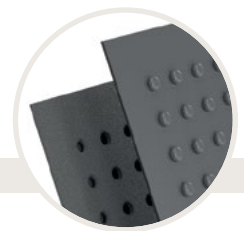

HAILO AS Allegro 380 28/13/13/D.

3301681



Trennung:	3-fach
Abfalleimer:	1 x 28 l, 2 x 13 l, Gesamtvolumen 54l, 1 Behälterdeckel 13 l
Montageart:	Schubkastenmontage, Seitenwandstärke 16 bis 19 mm
Schubkasten Nenntiefe:	≥ 500 mm
Deckel:	Kunststoff-Deckel herausziehbar, Seitenwandmontage
Farbe:	Kunststoffteile dunkelgrau
Produktmaße (B x T x H):	476 x 473 x 430 mm
Verpackungsmaße (B x T x H):	575 x 510 x 280 mm
Gewicht mit Verpackung:	5,1 kg
	Mit rutschhemmender Allegro Einlegematte

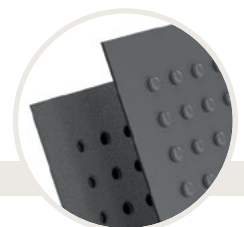

Einsatz für Schubkästen mit 600 mm Breite.

For common drawer cabinets of 600 mm width.

Separation: 3-fold
Inner bins: 1 x 28 l, 2 x 13 l, Total capacity 54 l, 1 lid 13 l
Type of installation: inside available drawer, side-wall-thickness 16 - 19 mm
Nominal drawer-depth: ≥ 500 mm
Lid: Plastic-lid single extension, sidewall-mounted
Colour: Plastic parts dark-grey
Product dimensions (W x D x H): 476 x 473 x 397 mm
Packing dimensions (W x D x H): 575 x 510 x 280 mm
Weight incl. packing: 4,5 kg
 With anti-slip Allegro mat



3301661



4 007126 306234

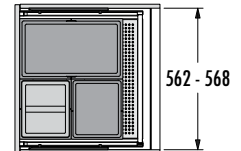
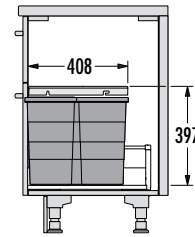

Separation: 2-fold
Inner bins: 2 x 28 l, Total capacity 56 l
Type of installation: inside available drawer, side-wall-thickness 16 - 19 mm
Nominal drawer-depth: ≥ 500 mm
Lid: Plastic-lid single extension, sidewall-mounted
Colour: Plastic parts dark-grey
Product dimensions (W x D x H): 476 x 473 x 430 mm
Packing dimensions (W x D x H): 575 x 510 x 280 mm
Weight incl. packing: 4,4 kg
 With anti-slip Allegro mat



3301671



4 007126 306241

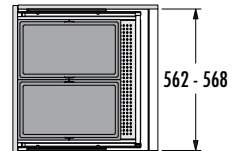
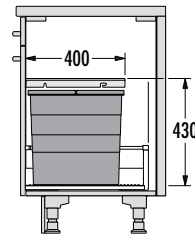

Separation: 3-fold
Inner bins: 1 x 28 l, 2 x 13 l, Total capacity 54 l, 1 lid 13 l
Type of installation: inside available drawer, side-wall-thickness 16 - 19 mm
Nominal drawer-depth: ≥ 500 mm
Lid: Plastic-lid single extension, sidewall-mounted
Colour: Plastic parts dark-grey
Product dimensions (W x D x H): 476 x 473 x 430 mm
Packing dimensions (W x D x H): 575 x 510 x 280 mm
Weight incl. packing: 5,1 kg
 With anti-slip Allegro mat



3301681



4 007126 306609

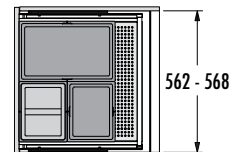
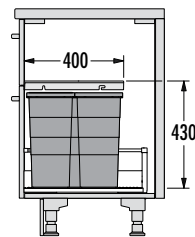

30 cm

40 cm

45 cm

50 cm

60 cm

80 cm

90 cm

Inch



Übrigens, wussten Sie, ...

By the way, did you know ...

... dass HAILO bereits 1993 ein Abfalltrennsystem mit Frontanbindung und Auszugsschienen auf den Markt brachte und somit als Pionier dieser Systeme gilt?

... that HAILO as a pioneer launched a waste separation system with front attachment and drawer slides in 1993?

75 CM



Für Schränke mit 750 mm Breite mit Frontauszug.

For cabinets with front-mount-door of 750 mm width.



75 CM SLIDE.

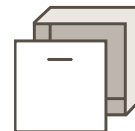

HAILO AS Cargo Aqua 750 28/18.



3608751

NEW

Der HAILO Cargo Aqua ist ein Abfalltrennsystem für Frontauszugsschränke/Spülenunterschränke, in denen seitlich ein Wasseraufbereiter integriert werden soll.

Trennung:	2-fach
Abfalleimer:	1 x 28 l, 1 x 18 l, Gesamtvolumen 46 l
Montageart:	Seitenwandmontage, selbstjustierend 16 - 19 mm
Auszugsschienen:	abgedeckter, gedämpfter Selbsteinzug mit synchronisiertem Überauszug
Systemtiefe:	420 mm
Farbe:	Metall- und Kunststoffteile dunkelgrau
Produktmaße (B x T x H):	502 x 420 x 411 mm
Verpackungsmaße (B x T x H):	510 x 430 x 520 mm
Gewicht mit Verpackung:	14 kg
Rechts und links im Schrank verwendbar / Platz für Wasseraufbereiter: 215 mm	

Für Schränke mit 750 mm Breite mit Frontauszug.

For cabinets with front-mount-door of 750 mm width.

The HAILO Cargo Aqua is a waste separation system for front-mount-door cabinets/sink base units in which a water purifier is to be integrated at the side.

Separation:	2-fold
Inner bins:	1 x 28 l, 1 x 18 l, Total capacity 46 l
Type of installation:	side-wall-mounted, self-adjusting to 16 - 19 mm side walls mounts
Slides:	covered, dampened slides with self-closing device with fully synchronized over-travel
System-depth:	420 mm
Colour:	Metal and plastic parts dark grey
Product dimensions (W x D x H):	502 x 420 x 411 mm
Packing dimensions (W x D x H):	510 x 430 x 520 mm
Weight incl. packing:	14 kg
Can be used on the right and left in the cabinet / Space for water purifier: 215 mm	



3608751



4 007126 306661

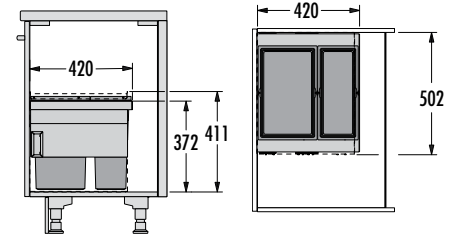

30 cm

40 cm

45 cm

50 cm

75 cm

80 cm

90 cm

Inch

**H
E
S
N**



Übrigens, wussten Sie, ...

By the way, did you know ...

*... dass HAILO Einbau-Abfallsammler ausnahmslos
in Deutschland hergestellt werden?*

*... that HAILO built-in waste separation systems are
exclusively manufactured in Germany?*

80 CM



Einsatz für Schubkästen mit 800 mm Breite.
For common drawer cabinets of 800 mm width.



30 cm

40 cm

45 cm

50 cm

60 cm

80 cm

90 cm

Inch

80 CM INSET.

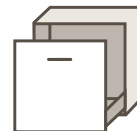

HAILO AS Triple XL 800 28/28/18.

3631881



Trennung:	3-fach
Abfalleimer:	2 x 28 l, 1 x 18 l, Gesamtvolumen 74 l
Montageart:	Schubkastenmontage, Seitenwandstärke 16 bis 19 mm
Schubkasten Nenntiefe:	≥ 420 mm
Deckel:	Metallsystemdeckel
Farbe:	Metall- und Kunststoffteile dunkelgrau
Produkt-Maße (T x H):	400 x 402 mm
Verpackungsmaße (B x T x H):	775 x 415 x 320 mm
Gewicht mit Verpackung:	11,7 kg

HAILO AS XXL 800 18/D/18/D/12/P/P/P.

3630801



Trennung:	3-fach
Abfalleimer:	2 x 18 l, 1 x 12 l, Gesamtvolumen 48 l, 2 x Behälterdeckel 18 l, 3 x Putzmittelkorb 4,1 l
Montageart:	Schubkastenmontage, Seitenwandstärke 16 bis 19 mm
Schubkasten Nenntiefe:	≥ 500 mm
Farbe:	Metallteile silberfarben, Kunststoffteile hellgrau
Produkt-Maße (T x H):	433 x 300 mm
Verpackungsmaße (B x T x H):	760 x 275 x 455 mm
Gewicht mit Verpackung:	9 kg
Nicht für Blum Legra Box F	

Einsatz für Schubkästen mit 800 mm Breite.

For common drawer cabinets of 800 mm width.

Separation:	3-fold
Inner bins:	2 x 28 l, 1 x 18 l, Total capacity 74 l
Type of installation:	inside available drawer, side-wall-thickness 16 - 19 mm
Nominal drawer-depth:	≥ 420 mm
Lid:	Sheet metal system Lid
Colour:	Metal and plastic parts dark grey
Product dimensions (D x H):	400 x 402 mm
Packing dimensions (W x D x H):	775 x 415 x 320 mm
Weight incl. packing:	11,7 kg

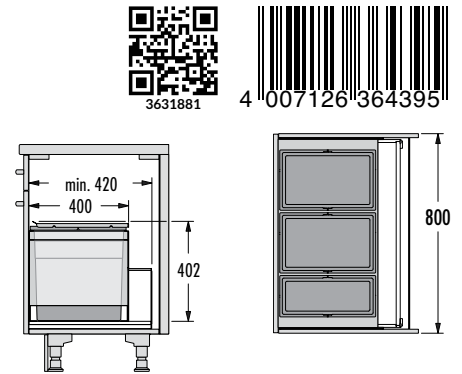

Separation:	3-fold
Inner bins:	2 x 18 l, 1 x 12 l, Total capacity 48 l 2 x Lid 18 l, 3 x Cleanser basket 4.1 l
Type of installation:	inside available drawer, side-wall-thickness 16 - 19 mm
Nominal drawer-depth:	≥ 500 mm
Colour:	Metal parts silver-coloured, plastic parts light grey
Product dimensions (D x H):	433 x 300 mm
Packing dimensions (W x D x H):	760 x 275 x 455 mm
Weight incl. packing:	9 kg
Not suitable for Blum Legra Box F	

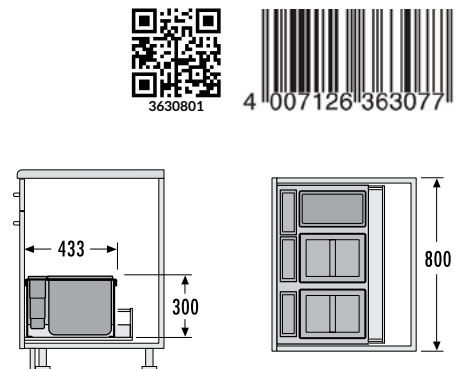

30 cm

40 cm

45 cm

50 cm

60 cm

80 cm

90 cm

Inch



SWING

Übrigens, wussten Sie, ...

By the way, did you know ...

... dass der HAILO Rondo das erste ganzheitliche Abfalltrenn- und Ordnungssystem für Eckspülenschränke war und bis heute als das Original schlechthin gilt?

... that the HAILO Rondo is the first integrated waste separation and order system for corner sink units and is still regarded as the original today?

90 CM



Für Diagonal-Eckspülenschränke ab 900 mm Breite.

For diagonal door corner-sink-cabinets from 900 mm width.



90 CM SWING.



HAILO Rondo® 18/18/ME.

3645121



Trennung:	2-fach, drehbar
Abfalleimer:	2 x 18 l, Gesamtvolumen 36 l, 1 x Multifunktionseimer 12 l mit Lochdeckel, 2 x Utensilienschalen
Montageart:	Bodenmontage, 360° drehbar
Auszugsschienen:	Vollauszug
Farbe:	Metallteile silberfarben, weiß, Kunststoffteile hellgrau
Einbau-Maße (B x T x H):	336 x 700 x 351 mm
Produkt-Maße:	ø 700 mm
Verpackungsmaße (B x T x H):	680 x 560 x 410 mm
Gewicht mit Verpackung:	12,5 kg

HAILO Rondo® 18/8/8/D/ME.

3646131



Trennung:	3-fach, drehbar
Abfalleimer:	1 x 18 l, 2 x 8 l, Gesamtvolumen 34 l, 1 x Multifunktionseimer 12 l mit Lochdeckel, 2 x Utensilienschalen, 1 x Behälterdeckel 8 l
Montageart:	Bodenmontage, 360° drehbar
Auszugsschienen:	Vollauszug
Farbe:	Metallteile silberfarben, weiß, Kunststoffteile hellgrau
Einbau-Maße (B x T x H):	336 x 700 x 351 mm
Produkt-Maße:	ø 700 mm
Verpackungsmaße (B x T x H):	680 x 560 x 410 mm
Gewicht mit Verpackung:	13 kg

HAILO Rondo® 8/8/8/8/D/ME.

3647141



Trennung:	4-fach, drehbar
Abfalleimer:	4 x 8 l, Gesamtvolumen 32 l, 1 x Multifunktionseimer 12 l mit Lochdeckel, 2 x Utensilienschalen, 1 x Behälterdeckel 8 l
Montageart:	Bodenmontage, 360° drehbar
Auszugsschienen:	Vollauszug
Farbe:	Metallteile silberfarben, weiß, Kunststoffteile hellgrau
Einbau-Maße (B x T x H):	336 x 700 x 351 mm
Produkt-Maße:	ø 700 mm
Verpackungsmaße (B x T x H):	680 x 560 x 410 mm
Gewicht mit Verpackung:	13,1 kg

Für Diagonal-Eckspülenschränke ab 900 mm Breite.

For diagonal door corner-sink-cabinets from 900 mm width.

Separation: 2-fold, swivelling
Inner bins: 2 x 18 l, Total capacity 36 l,
 1 x Multifunctional bucket 12 l with perforated lid,
 2 x Utensil-side-baskets
Type of installation: bottom mounted, Turnable 360°
Slides: full extension
Colour: Metal parts silver-coloured, white, Plastic parts light grey
Built-in dimensions (W x D x H): 336 x 700 x 351 mm
Product dimensions: ø 700 mm
Packing dimensions (W x D x H): 680 x 560 x 410 mm
Weight incl. packing: 12,5 kg

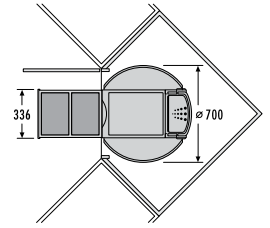
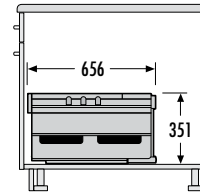

Separation: 3-fold, swivelling
Inner bins: 1 x 18 l, 2 x 8 l, Total capacity 34 l,
 1 x Multifunctional bucket 12 l with perforated lid,
 2 x Utensil-side-baskets, 1 x Lid 8 l
Type of installation: bottom mounted, Turnable 360°
Slides: full extension
Colour: Metal parts silver-coloured, white, Plastic parts light grey
Built-in dimensions (W x D x H): 336 x 700 x 351 mm
Product dimensions: ø 700 mm
Packing dimensions (W x D x H): 680 x 560 x 410 mm
Weight incl. packing: 13 kg

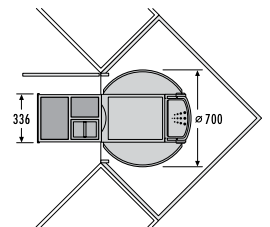
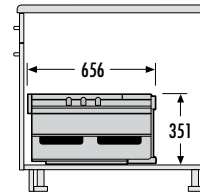

Separation: 4-fold, swivelling
Inner bins: 4 x 8 l, Total capacity 32 l,
 1 x Multifunctional bucket 12 l with perforated lid,
 2 x Utensil-side-baskets, 1 x Lid 8 l
Type of installation: bottom mounted, Turnable 360°
Slides: full extension
Colour: Metal parts silver-coloured, white, Plastic parts light grey
Built-in dimensions (W x D x H): 336 x 700 x 351 mm
Product dimensions: ø 700 mm
Packing dimensions (W x D x H): 680 x 560 x 410 mm
Weight incl. packing: 13,1 kg

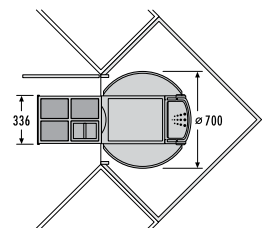
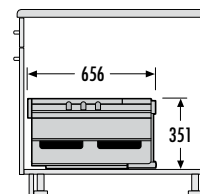

30 cm

40 cm

45 cm

50 cm

60 cm

80 cm

90 cm

Inch

90 CM SWING.



HAILO AS Rondo® Comfort 20/20/KS/ME.

3645221

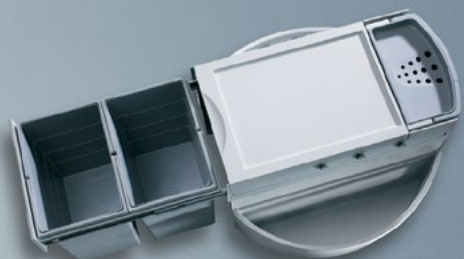

Trennung:	2-fach, drehbar
Abfalleimer:	2 x 20 l, Gesamtvolumen 40 l, 1 x Multifunktionseimer 12 l mit Lochdeckel, 2 x Utensilienschalen
Montageart:	Bodenmontage, 360° drehbar
Auszugsschienen:	Vollauszug
Farbe:	Metallteile silberfarben, weiß, Kunststoffteile hellgrau
Einbau-Maße (B x T x H):	336 x 700 x 406 mm
Produkt-Maße:	ø 700 mm
Verpackungsmaße (B x T x H):	680 x 620 x 410 mm
Gewicht mit Verpackung:	14,0 kg
Mit integriertem Kehr-Set, Kunststoff rot	

HAILO Rondo® Comfort 20/10/10/D/KS/ME.

3646231



Trennung:	3-fach, drehbar
Abfalleimer:	1 x 20 l, 2 x 10 l, Gesamtvolumen 40 l, 1 x Multifunktionseimer 12 l mit Lochdeckel, 2 x Utensilienschalen, 1x Behälterdeckel 10 l
Montageart:	Bodenmontage, 360° drehbar
Auszugsschienen:	Vollauszug
Farbe:	Metallteile silberfarben, weiß, Kunststoffteile hellgrau
Einbau-Maße (B x T x H):	336 x 700 x 406 mm
Produkt-Maße:	ø 700 mm
Verpackungsmaße (B x T x H):	680 x 620 x 410 mm
Gewicht mit Verpackung:	15 kg
Mit integriertem Kehr-Set, Kunststoff rot	

HAILO Schlauchbrausenabweiser. *HAILO Wall-Bracket for Flex-Hose.*

3693001



Metallbügel zum Einbau in Spülenunterschranke zur gezielten Schlauchführung.

Verpackungseinheit:	5
Verpackungsmaße (B x T x H):	445 x 190 x 85 mm
Gewicht mit Verpackung:	0,2 kg



Für Diagonal-Eckspülenschränke ab 900 mm Breite.

For diagonal door corner-sink-cabinets from 900 mm width.

Separation: 2-fold, swivelling
Inner bins: 2 x 20 l, Total capacity 40 l
 1 x Multifunctional bucket 12 l with perforated lid,
 2 x Utensil-side-baskets
Type of installation: bottom mounted, Turnable 360°
Slides: full extension
Colour: Metal parts silver-coloured, white, Plastic parts light grey
Built-in dimensions (W x D x H): 336 x 700 x 406 mm
Product dimensions: ø 700 mm
Packing dimensions (W x D x H): 680 x 620 x 410 mm
Weight incl. packing: 14,0 kg
 With dust-pan and a brush, Plastic red

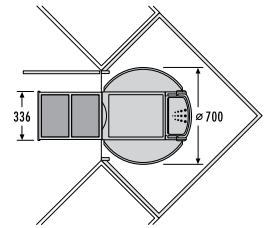
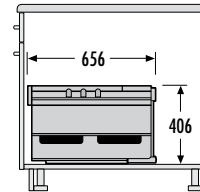

Separation: 3-fold, swivelling
Inner bins: 1 x 20 l, 2 x 10 l, Total capacity 40 l,
 1 x Multifunctional bucket 12 l with perforated lid,
 2 x Utensil-side-baskets, 1x Lid 10 l
Type of installation: bottom mounted, Turnable 360°
Slides: full extension
Colour: Metal parts silver-coloured, white, Plastic parts light grey
Built-in dimensions (W x D x H): 336 x 700 x 406 mm
Product dimensions: ø 700 mm
Packing dimensions (W x D x H): 680 x 620 x 410 mm
Weight incl. packing: 15 kg
 With dust-pan and a brush, Plastic red

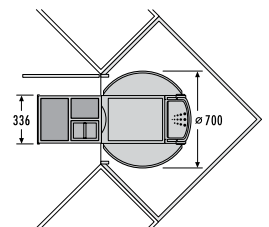
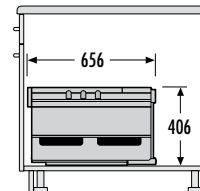

Wire bracket for sink-cabinets,
 for rerouting of flexible hoses.

Packing unit: 5 each per carton
Packing dimensions (W x D x H): 445 x 190 x 85 mm
Weight incl. packing: 0,2 kg



30 cm

40 cm

45 cm

50 cm

60 cm

80 cm

90 cm

Inch



Übrigens, wussten Sie, ...

By the way, did you know ...

... dass HAILO Einbautechnik-Produkte mit über 100.000 Auszugszyklen getestet werden, bevor sie auf den Markt kommen?

... that HAILO Built-In Technology Products are tested on more than 100,000 pull-out cycles before they reach the market?

90 CM



Für Schränke mit 900 mm Breite mit Frontauszug.

For cabinets with front-mount-door of 900 mm width.



30 cm

40 cm

45 cm

50 cm

60 cm

80 cm

90 cm

Inch

90 CM SLIDE.

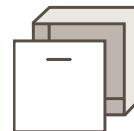

HAILO AS Cargo Aqua 900 28/13/13/D.



3608901

NEW

Der HAILO Cargo Aqua ist ein Abfalltrennsystem für Frontauszugsschränke/Spülenunterschranke, in denen seitlich ein Wasseraufbereiter integriert werden soll.

Trennung:	3-fach
Abfalleimer:	1 x 28 l, 2 x 13 l, Gesamtvolumen 54 l, 1 Behälterdeckel 13 l
Montageart:	Seitenwandmontage, selbstjustierend 16 - 19 mm
Auszugsschienen:	abgedeckter, gedämpfter Selbsteinzug mit synchronisiertem Überauszug
Systemtiefe:	400 mm
Farbe:	Metall- und Kunststoffteile dunkelgrau
Produktmaße (B x T x H):	573 x 400 x 411 mm
Verpackungsmaße (B x T x H):	680 x 410 x 560 mm
Gewicht mit Verpackung:	15 kg
Rechts und links im Schrank verwendbar / Platz für Wasseraufbereiter: 290 mm	



Für Schränke mit 900 mm Breite mit Frontauszug.

For cabinets with front-mount-door of 900 mm width.

The HAILO Cargo Aqua is a waste separation system for front-mount-door cabinets/sink base units in which a water purifier is to be integrated at the side.

Separation:	<i>3-fold</i>
Inner bins:	<i>1 x 28 l, 2 x 13 l, Total capacity 54 l, 1 lid 13 l</i>
Type of installation:	<i>side-wall-mounted, self-adjusting to 16 - 19 mm side walls mounts</i>
Slides:	covered, dampened slides with self-closing device with fully synchronized over-travel
System-depth:	<i>400 mm</i>
Colour:	<i>Metal and plastic parts dark grey</i>
Product dimensions (W x D x H):	<i>573 x 400 x 411 mm</i>
Packing dimensions (W x D x H):	<i>680 x 410 x 560 mm</i>
Weight incl. packing:	<i>15 kg</i>
<i>Can be used on the right and left in the cabinet / Space for water purifier: 290 mm</i>	



3608901



4 007126 306678

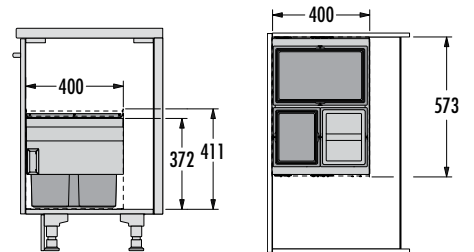

30 cm

40 cm

45 cm

50 cm

60 cm

80 cm

90 cm

Inch



Übrigens, wussten Sie, ...

By the way, did you know ...

... dass HAILO für die meisten Produkte eine Montageanleitung auf der Website zur Verfügung stellt?

... that HAILO installation instructions for most products are available on the website?

90 CM



Einsatz für Schubkästen mit 900 mm Breite.
For common drawer cabinets of 900 mm width.



30 cm

40 cm

45 cm

50 cm

60 cm

80 cm

90 cm

Inch

90 CM INSET.

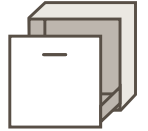

HAILO AS Triple XL 900 28/28/28.

3631981



Trennung:	3-fach
Abfalleimer:	3 x 28 l, Gesamtvolumen 84 l,
Montageart:	Schubkastenmontage, Seitenwandstärke 16 - 19 mm
Schubkasten Nenntiefe:	≥ 420 mm
Deckel:	Metall-Systemdeckel
Farbe:	Metall- und Kunststoffteile dunkelgrau
Produkt-Maße (T x H):	400 x 402 mm
Verpackungsmaße (B x T x H):	865 x 415 x 320 mm
Gewicht mit Verpackung:	12,2 kg

HAILO AS XXL 900 18/D/18/D/12/12/P/P/U/U.

3630901



Trennung:	4-fach
Abfalleimer:	2 x 18 l, 2 x 12 l, Gesamtvolumen 60 l, 2 x Behälterdeckel 18 l, 2 x Putzmittelkorb 4,1 l, 2 x Utensiliendepot 0,7 l
Montageart:	Schubkastenmontage, Seitenwandstärke 16 bis 19 mm
Schubkasten Nenntiefe:	≥ 500
Farbe:	Metallteile silberfarben, Kunststoffteile grau
Produkt-Maße (T x H):	433 x 300 mm
Verpackungsmaße (B x T x H):	860 x 275 x 455 mm
Gewicht mit Verpackung:	10,2 kg
Nicht für Blum Legra Box F	

HAILO AS Separato K 900 18/18/8/8/D/KS.

3620901



Trennung:	4-fach
Abfalleimer:	2 x 18 l, 2 x 8 l, Gesamtvolumen 52 l, 1 x Behälterdeckel 8 l
Montageart:	Schubkastenmontage, Seitenwandstärke 16 bis 19 mm
Schubkasten Nenntiefe:	≥ 500 mm
Deckel:	Metallsystemdeckel
Farbe:	Metallteile silberfarben, Kunststoffteile hellgrau
Produktmaße (B x T x H):	860 x 491 x 340 mm
Verpackungsmaße (B x T x H):	880 x 530 x 300 mm
Gewicht mit Verpackung:	8 kg
Mit integriertem Kehr-Set	
Nicht für Blum Legra Box F	

Einsatz für Schubkästen mit 900 mm Breite.

For common drawer cabinets of 900 mm width.

Separation: 3-fold
 Inner bins: 3 x 28 l, Total capacity 84 l
Type of installation: **inside available drawer,**
 side-wall-thickness 16 - 19 mm
 Nominal drawer-depth: ≥ 420 mm
 Lid: Sheet metal system Lid
 Colour: Metal and plastic parts dark grey
 Product dimensions (D x H): 400 x 402 mm
 Packing dimensions (W x D x H): 865 x 415 x 320 mm
 Weight incl. packing: 12,2 kg



3631981



4 007126 364449

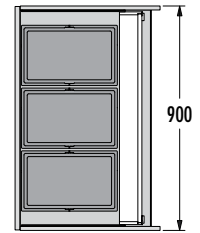
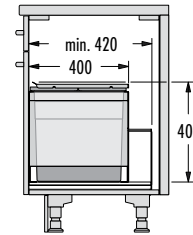

Separation: 4-fold
 Inner bins: 2 x 18 l, 2 x 12 l, Total capacity 60 l
 2 x Lid 18 l, 2 x Cleaners basket 4.1 l,
 2 x utensil depot 0.7 l
Type of installation: **inside available drawer,**
 side-wall-thickness 16 - 19 mm
 Nominal drawer-depth: ≥ 500 mm
 Colour: Metal parts silver-coloured, plastic parts grey
 Product dimensions (D x H): 433 x 300 mm
 Packing dimensions (W x D x H): 860 x 275 x 455 mm
 Weight incl. packing: 10,2 kg
 Not suitable for Blum Legra Box F



3630901



4 007126 363091

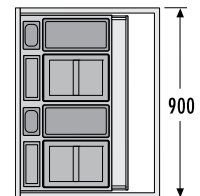
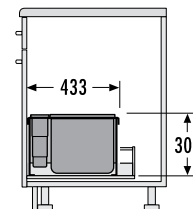

Separation: 4-fold
 Inner bins: 2 x 18 l, 2 x 8 l, Total capacity 52 l, 1 x Lid 8 l
Type of installation: **inside available drawer,**
 side-wall-thickness 16 - 19 mm

Nominal drawer-depth ≥ 500 mm
 Lid: Sheet metal system Lid, silver-coloured, sidewall-mounted
 Colour: Metal parts silver-coloured, plastic parts light grey
 Product dimensions (W x D x H): 860 x 491 x 340 mm
 Packing dimensions (W x D x H): 880 x 530 x 300 mm
 Weight incl. packing: 8 kg
 Equipped with a dust-pan and a brush
 Not suitable for Blum Legra Box F



3620901



4 007126 362247

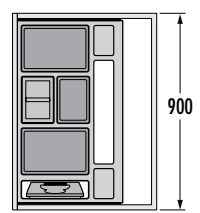
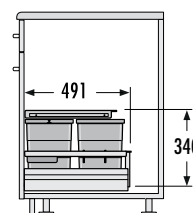

30 cm

40 cm

45 cm

50 cm

60 cm

80 cm

90 cm

Inch

90 CM INSET.



HAILO AS Separato K 900 18/18/8/8/D/KS.

3620911



Trennung:	4-fach
Abfalleimer:	2 x 18 l, 2 x 8 l, Gesamtvolumen 52 l, 1 x Behälterdeckel 8 l
Montageart:	Schubkastenmontage, Seitenwandstärke 16 bis 19 mm
Schubkasten Nenntiefe:	≥ 500 mm
Deckel:	Kunststoff-Deckel herausziehbar
Farbe:	Kunststoffteile hellgrau
Produktmaße (B x T x H):	860 x 491 x 340 mm
Verpackungsmaße (B x T x H):	880 x 530 x 300 mm
Gewicht mit Verpackung:	7,7 kg
Mit integriertem Kehr-Set	
Nicht für Blum Legra Box F	

Einsatz für Schubkästen mit 900 mm Breite.

For common drawer cabinets of 900 mm width.

Separation:	4-fold
Inner bins:	2 x 18 l, 2 x 8 l, Total capacity 52 l, 1 x Lid 8 l
Type of installation:	inside available drawer, side-wall-thickness 16 - 19 mm
Nominal drawer-depth:	≥ 500 mm
Lid:	Plastic-lid single extension, sidewall-mounted
Colour:	Plastic parts light-grey
Product dimensions (W x D x H):	860 x 491 x 340 mm
Packing dimensions (W x D x H):	880 x 530 x 300 mm
Weight incl. packing:	7,7 kg
Equipped with a dust-pan and a brush	
Not suitable for Blum Legra Box F	



3620911



4 007126 362070

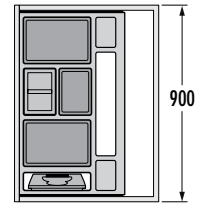
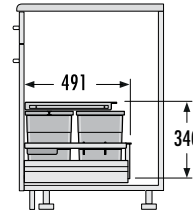

30 cm

40 cm

45 cm

50 cm

60 cm

80 cm

90 cm

Inch



Übrigens, wussten Sie, ...

By the way, did you know ...

... dass HAILO Einbautechnik weltweit in über 80 Länder exportiert?

... that HAILO Built-In Technology exports to more than 80 countries around the world?

15" | 18" | 21" | 24"



Für Frontrahmen- und Kastenschränke mit Frontauszug.

For face frame and frameless cabinets with front-mount-door.



INCH SLIDE.

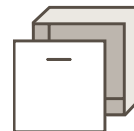

HAILO US Cargo 15" 37/15/D.

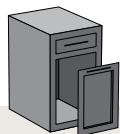

3613311



Für Schrankbreite (inch):	15"
Trennung:	2-fach
Abfalleimer:	1 x 37 l, 1 x 15 l, Gesamtvolumen 52 l, 1 x Behälterdeckel 15 l
Montageart:	Seitenwandmontage, selbstjustierend 12 - 19 mm
Auszugsschienen:	abgedeckter, gedämpfter Selbsteinzug mit synchronisiertem Überauszug
Systemtiefe:	569 mm
Schrankschranktiefe mind. (nutzbar):	570 mm + Rahmendicke
Deckel:	Metallsystemdeckel
Farbe:	Metallteile silberfarben, Kunststoffteile hellgrau
Produktmaße (B x T x H):	343-357 x 588 x 527 mm
Verpackungsmaße (B x T x H):	512 x 362 x 600 mm
Gewicht mit Verpackung:	13 kg

HAILO US Cargo 18" 37/15/D.

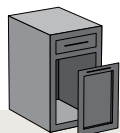

3613331



Für Schrankbreite (inch):	18"
Trennung:	2-fach
Abfalleimer:	1 x 37 l, 1 x 15 l, Gesamtvolumen 52 l, 1 x Behälterdeckel 15 l
Montageart:	Seitenwandmontage, selbstjustierend 12 - 19 mm
Auszugsschienen:	abgedeckter, gedämpfter Selbsteinzug mit synchronisiertem Überauszug
Systemtiefe:	569 mm
Schrankschranktiefe mind. (nutzbar):	570 mm + Rahmendicke
Deckel:	Metallsystemdeckel
Farbe:	Metallteile silberfarben, Kunststoffteile hellgrau
Produktmaße (B x T x H):	419-433 x 588 x 527 mm
Verpackungsmaße (B x T x H):	512 x 362 x 600 mm
Gewicht mit Verpackung:	13,8 kg

HAILO US Cargo 21" 42/42.

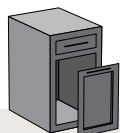

3613351



Für Schrankbreite (inch):	21"
Trennung:	2-fach
Abfalleimer:	2 x 42 l, Gesamtvolumen 84 l
Montageart:	Seitenwandmontage, selbstjustierend 12 - 19 mm
Auszugsschienen:	abgedeckter, gedämpfter Selbsteinzug mit synchronisiertem Überauszug
Systemtiefe:	569 mm
Schrankschranktiefe mind. (nutzbar):	570 mm + Rahmendicke
Deckel:	Metallsystemdeckel
Farbe:	Metallteile silberfarben, Kunststoffteile hellgrau
Produktmaße (B x T x H):	495-509 x 588 x 527 mm
Verpackungsmaße (B x T x H):	600 x 335 x 630 mm
Gewicht mit Verpackung:	14,4 kg

Für Frontrahmen Schränke mit Frontauszug.

For face frame cabinets with front-mount-door and 15", 18", 21" width.

For cabinet width (inch): 15"
 Separation: 2-fold
 Inner bins: 1 x 37 l, 1 x 15 l, Total capacity 52 l, 1 x Lid 15 l
 Type of installation: side-wall-mounted, self-adjusting to 12 - 19 mm side walls
Slides: covered, dampened slides with self-closing device with fully synchronized over-travel
 System-depth: 569 mm
 Min. cabinet depth (usable): 570 mm + frame thickness
 Lid: Sheet metal system lid
 Colour: Metal parts silver, plastic parts light-grey
 Product dimensions (W x D x H): 343-357 x 588 x 527 mm
 Packing dimensions (W x D x H): 512 x 362 x 600 mm
 Weight incl. packing: 13 kg

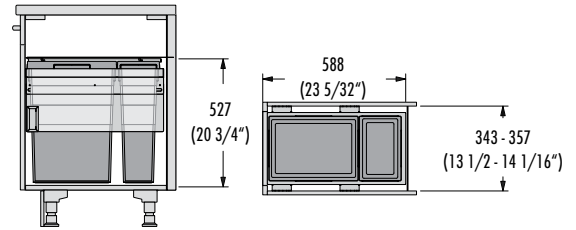

For cabinet width (inch): 18"
 Separation: 2-fold
 Inner bins: 1 x 37 l, 1 x 15 l, Total capacity 52 l, 1 x Lid 15 l
 Type of installation: side-wall-mounted, self-adjusting to 12 - 19 mm side walls
Slides: covered, dampened slides with self-closing device with fully synchronized over-travel
 System-depth: 569 mm
 Min. cabinet depth (usable): 570 mm + frame thickness
 Lid: Sheet metal system lid
 Colour: Metal parts silver, plastic parts light-grey
 Product dimensions (W x D x H): 419-433 x 588 x 527 mm
 Packing dimensions (W x D x H): 512 x 362 x 600 mm
 Weight incl. packing: 13,8 kg

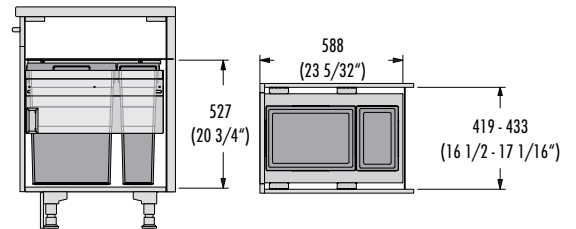

For cabinet width (inch): 21"
 Separation: 2-fold
 Inner bins: 2 x 42 l, Total capacity 84 l
 Type of installation: side-wall-mounted, self-adjusting to 12 - 19 mm side walls
Slides: covered, dampened slides with self-closing device with fully synchronized over-travel
 System-depth: 569 mm
 Min. cabinet depth (usable): 570 mm + frame thickness
 Lid: Sheet metal system lid
 Colour: Metal parts silver, plastic parts light-grey
 Product dimensions (W x D x H): 495-509 x 588 x 527 mm
 Packing dimensions (W x D x H): 600 x 335 x 630 mm
 Weight incl. packing: 14,4 kg

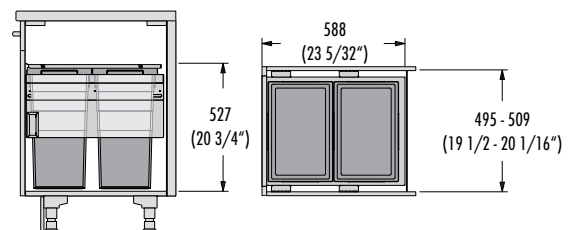

30 cm

40 cm

45 cm

50 cm

60 cm

80 cm

90 cm

Inch

INCH SLIDE.

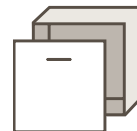

HAILO US Cargo 24" 42/42.

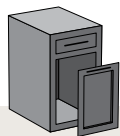

Für Schrankbreite (inch):	24"
Trennung:	2-fach
Abfalleimer:	2 x 42 l, Gesamtvolumen 84 l
Montageart:	Seitenwandmontage, selbstjustierend 12 - 19 mm
Auszugsschienen:	abgedeckter, gedämpfter Selbsteinzug mit synchronisiertem Überauszug
Systemtiefe:	569 mm
Schrankschranktiefe mind. (nutzbar):	570 mm + Rahmendicke
Deckel:	Metallsystemdeckel
Farbe:	Metallteile silberfarben, Kunststoffteile hellgrau
Produktmaße (B x T x H):	572-586 x 588 x 527 mm
Verpackungsmaße (B x T x H):	600 x 335 x 630 mm
Gewicht mit Verpackung:	15,3 kg

INCH SLIDE.



HAILO US Cargo 15" 37/15/D.

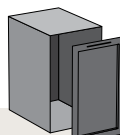

Für Schrankbreite (inch):	15"
Trennung:	2-fach
Abfalleimer:	1 x 37 l, 1 x 15 l, Gesamtvolumen 52 l, 1 x Behälterdeckel 15 l
Montageart:	Seitenwandmontage, selbstjustierend 16 - 19 mm
Auszugsschienen:	abgedeckter, gedämpfter Selbsteinzug mit synchronisiertem Überauszug
Systemtiefe:	569 mm
Schrankschranktiefe mind. (nutzbar):	570 mm
Deckel:	Metallsystemdeckel
Farbe:	Metallteile silberfarben, Kunststoffteile hellgrau
Produktmaße (B x T x H):	343-349 x 569 x 521 mm
Verpackungsmaße (B x T x H):	512 x 362 x 600 mm
Gewicht mit Verpackung:	13 kg

Für Frontrahmenschränke mit Frontauszug.

For face frame cabinets with front-mount-door and 24" width.

For cabinet width (inch):	24"
Separation:	2-fold
Inner bins:	2 x 42 l, Total capacity 84 l
Type of installation:	side-wall-mounted, self-adjusting to 12 - 19 mm side walls
Slides:	covered, dampened slides with self-closing device with fully synchronized over-travel
System-depth:	569 mm
Min. cabinet depth (usable):	570 mm + frame thickness
Lid:	Sheet metal system lid
Colour:	Metal parts silver, plastic parts light-grey
Product dimensions (W x D x H):	572-586 x 588 x 527 mm
Packing dimensions (W x D x H):	600 x 335 x 630 mm
Weight incl. packing:	15,3 kg

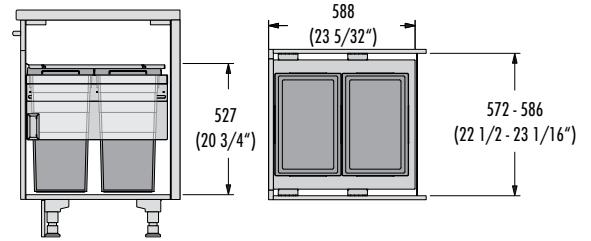

30 cm

40 cm

45 cm

50 cm

60 cm

80 cm

90 cm

Inch

Für Kastenschränke mit Frontauszug.

For frameless cabinets with front-mount-door and 15" width.

For cabinet width (inch):	15"
Separation:	2-fold
Inner bins:	1 x 37 l, 1 x 15 l, Total capacity 52 l, 1 x Lid 15 l
Type of installation:	side-wall-mounted, self-adjusting to 16 - 19 mm side walls
Slides:	covered, dampened slides with self-closing device with fully synchronized over-travel
System-depth:	569 mm
Min. cabinet depth (usable):	570 mm
Lid:	Sheet metal system lid
Colour:	Metal parts silver, plastic parts light-grey
Product dimensions (W x D x H):	343-349 x 569 x 521 mm
Packing dimensions (W x D x H):	512 x 362 x 600 mm
Weight incl. packing:	13 kg

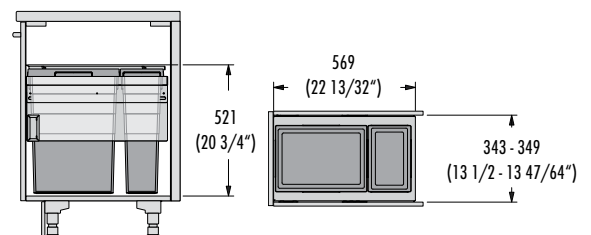

INCH SLIDE.

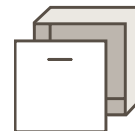

HAILO US Cargo 18" 37/37.

3613341

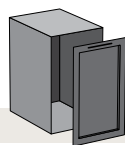

Füt Schrankbreite (inch):	18"
Trennung:	2-fach
Abfalleimer:	2 x 37 l, Gesamtvolumen 74 l
Montageart:	Seitenwandmontage, selbstjustierend 16 - 19 mm
Auszugsschienen:	abgedeckter, gedämpfter Selbsteinzug mit synchronisiertem Überauszug
Systemtiefe:	569 mm
Schrankschranktiefe mind. (nutzbar):	570 mm
Deckel:	Metallsystemdeckel
Farbe:	Metallteile silberfarben, Kunststoffteile hellgrau
Produktmaße (B x T x H):	419-425 x 569 x 521 mm
Verpackungsmaße (B x T x H):	512 x 362 x 600 mm mm
Gewicht mit Verpackung:	13,5 kg

HAILO US Cargo 21" 42/42.

3613361

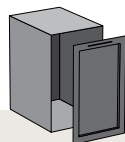

Füt Schrankbreite (inch):	21"
Trennung:	2-fach
Abfalleimer:	2 x 42 l, Gesamtvolumen 84 l
Montageart:	Seitenwandmontage, selbstjustierend 16 - 19 mm
Auszugsschienen:	abgedeckter, gedämpfter Selbsteinzug mit synchronisiertem Überauszug
Systemtiefe:	569 mm
Schrankschranktiefe mind. (nutzbar):	570 mm
Deckel:	Metallsystemdeckel
Farbe:	Metallteile silberfarben, Kunststoffteile hellgrau
Produktmaße (B x T x H):	495-501 x 569 x 521 mm
Verpackungsmaße (B x T x H):	600 x 335 x 630 mm
Gewicht mit Verpackung:	14,2 kg

HAILO US Cargo 24" 42/42.

3613381

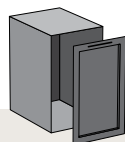

Füt Schrankbreite (inch):	24"
Trennung:	2-fach
Abfalleimer:	2 x 42 l, Gesamtvolumen 84 l
Montageart:	Seitenwandmontage, selbstjustierend 16 - 19 mm
Auszugsschienen:	abgedeckter, gedämpfter Selbsteinzug mit synchronisiertem Überauszug
Systemtiefe:	569 mm
Schrankschranktiefe mind. (nutzbar):	570 mm
Deckel:	Metallsystemdeckel
Farbe:	Metallteile silberfarben, Kunststoffteile hellgrau
Produktmaße (B x T x H):	572-578 x 569 x 521 mm
Verpackungsmaße (B x T x H):	600 x 335 x 630 mm
Gewicht mit Verpackung:	15,5 kg

Für Kastenschränke mit Frontauszug.

For frameless cabinets with front-mount-door and 18", 21", 24" width.

For cabinet width (inch): 18"
 Separation: 2-fold
 Inner bins: 2 x 37 l, Total capacity 74 l
 Type of installation: side-wall-mounted, self-adjusting to 16 - 19 mm side walls
Slides: covered, dampened slides with self-closing device with fully synchronized over-travel
 System-depth: 569 mm
 Min. cabinet depth (usable): 570 mm
 Lid: Sheet metal system lid
 Colour: Metal parts silver, plastic parts light-grey
 Product dimensions (W x D x H): 419-425 x 569 x 521 mm
 Packing dimensions (W x D x H): 512 x 362 x 600 mm
 Weight incl. packing: 13,5 kg

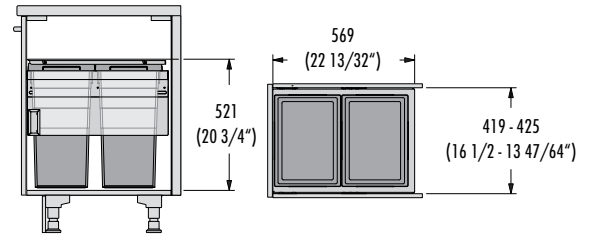

For cabinet width (inch): 21"
 Separation: 2-fold
 Inner bins: 2 x 42 l, Total capacity 84 l
 Type of installation: side-wall-mounted, self-adjusting to 16 - 19 mm side walls
Slides: covered, dampened slides with self-closing device with fully synchronized over-travel
 System-depth: 569 mm
 Min. cabinet depth (usable): 570 mm
 Lid: Sheet metal system lid
 Colour: Metal parts silver, plastic parts light-grey
 Product dimensions (W x D x H): 495-501 x 569 x 521 mm
 Packing dimensions (W x D x H): 600 x 335 x 630 mm
 Weight incl. packing: 14,2 kg

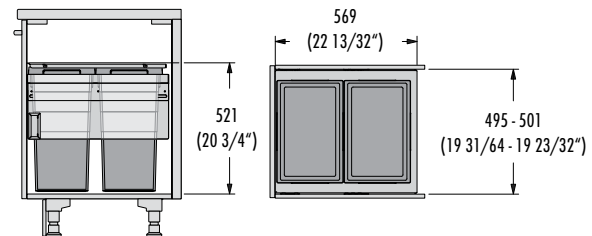

For cabinet width (inch): 24"
 Separation: 2-fold
 Inner bins: 2 x 42 l, Total capacity 84 l
 Type of installation: side-wall-mounted, self-adjusting to 16 - 19 mm side walls
Slides: covered, dampened slides with self-closing device with fully synchronized over-travel
 System-depth: 569 mm
 Min. cabinet depth (usable): 570 mm
 Lid: Sheet metal system lid
 Colour: Metal parts silver, plastic parts light-grey
 Product dimensions (W x D x H): 572-578 x 569 x 521 mm
 Packing dimensions (W x D x H): 600 x 335 x 630 mm
 Weight incl. packing: 15,5 kg

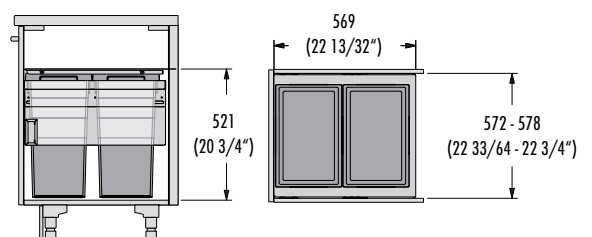

30 cm

40 cm

45 cm

50 cm

60 cm

80 cm

90 cm

Inch



Ordnungssysteme.

Organizer systems.

30 cm

40 cm

45 cm

50 cm

60 cm

80 cm

90 cm

Inch



174 - 177
Micro Garden.



178 - 183
Haustierstation.
Pet station.



184 - 187
Pantry Box.



188 - 193
Handtuchhalter.
Towel rail.

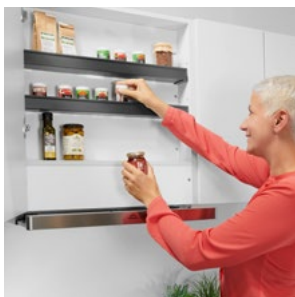

194 - 197
Deposito Regalsystem.
Deposito rack system.



198 - 201
Vario.



202 - 205
Carry.





HAILO Micro Garden.

Das smarte Einbausystem zur Anzucht gesunder Microgreens.

The smart built-in system for growing healthy microgreens.



Einsatz für Schubkästen mit 600 mm Breite.

For common drawer cabinets of 600 mm width.

60 CM INSET.

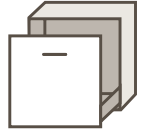

HAILO Micro Garden.



3970601

Smartes Einbausystem zur Anzucht vielfältiger Microgreens.
Ordentlich verstaut in Schubladen mit 60 cm Breite.
Sauber und hygienisch dank Saatgut-Pads – keine Pflanzerde notwendig. Vier herausnehmbare Schälchen für die Anzucht unterschiedlicher Sprossen. Aufwandsarm dank automatisierter Belichtung und Belüftung.
Bequeme Steuerung per App.

Gesunde Microgreens aus der Schublade

Mit dem HAILO Micro Garden wird die Anzucht von Microgreens zur sauberen Sache. Ordentlich in der Schublade verstaut und aufwandsarm dank App-Steuerung sowie automatisierter Belichtung und Belüftung, gelingt die Anzucht der gesunden Sprossen kinderleicht. Die aromatischen Keimlinge können bereits nach 5-10 Tagen geerntet werden und bereichern den Speiseplan ganzjährig mit wohlschmeckenden Aromen und gesunden Vitalstoffen.



Microgreens: aromatische Superfoods.

Microgreens sind ein absolutes Trendthema im Bereich der gesunden Ernährung. Die gesunden und nährstoffreichen Keimlinge von Gemüse- und Kräuterpflanzen verfeinern dank ihrer vielfältigen Aromen Gerichte wie Suppen, Sandwiches und Salate. Die Anzucht der vielseitigen Sprossen gelingt ohne Erde auf speziellen Saatgut-Pads und ist daher besonders sauber und hygienisch – perfekt für die heimische Küche!

Für Unterschränke 600 mm Breite
Lichtmodul mit spezieller Pflanzen-LED im Deckel
Automatischer Tag-Nacht-Zyklus
Smarte Steuerung über eine App
Zwei unterschiedliche Pflanzenprogramme gleichzeitig möglich
Standard-Pflanzenprogramm auch offline möglich
Stromversorgung über 12-V-Netzteil
Deckel: Schiebedeckel mit Lichtpanel

Montageart: Schubkasteneinsatz für alle handelsüblichen Schubkastensysteme

(Seitenwandstärke 16 mm)

Farbe:	Kunststoffteile weiß, dunkelgrau
Produkt-Maße (T x H):	490 x 235 mm
Schubkasten Nenntiefe:	500 mm
Verpackungsmaße (B x T x H):	730 x 600 x 330 mm
Gewicht mit Verpackung:	10,1 kg

Ganzjährig wachsende Microgreens – sauber und ordentlich in der Schublade

Microgreens that grow all year round – neat and tidy in the drawer



Vier herausnehmbare Schälchen für die Anzucht unterschiedlicher Sprossen

Four removable trays for growing different sprouts





Einsatz für Schubkästen mit 600 mm Breite.

For common drawer cabinets of 600 mm width.

Smart built-in system for growing a variety of microgreens.
Neatly stored in drawers with a width of 60 cm.
Clean and hygienic thanks to seed pads - no planting soil required.
Four removable trays for growing different sprouts.
Low effort thanks to automated lighting and ventilation.
Convenient control via app.

Healthy microgreens from the drawer

With the HAILO Micro Garden, growing microgreens is a clean affair. Neatly stored in the drawer and with little effort thanks to app control and automated lighting and ventilation, growing healthy sprouts is child's play. The aromatic sprouts can be harvested after only 5-10 days and enrich the menu with tasty flavours and healthy vital substances all year round.

Microgreens: aromatic superfoods.

Microgreens are an absolute trend topic in the field of healthy nutrition. The healthy and nutrient-rich sprouts of vegetable and herb plants refine dishes such as soups, sandwiches and salads thanks to their diverse aromas. The versatile sprouts can be grown without soil on special seed pads and are therefore particularly clean and hygienic – perfect for the kitchen at home!

For 600 mm wide drawer-cabinets
Light module with special plant LED in the lid
Automatic day-night cycle
Smart control via an app
Two different plant programmes possible at the same time
Standard plant programme also possible offline
Power supply via 12 V mains adapter
Lid: Sliding lid with light panel

Type of installation: for any common standard-drawers in boxed kitchen- and base-cabinets
(with sidewall thickness from 16 mm)

Colour: Plastic parts white, dark grey
Product dimensions (D x H): 490 x 235 mm
Nominal depth: 500 mm
Packing dimensions (W x D x H): 730 x 600 x 330 mm
Weight incl. packing: 10,1 kg



Youtube:
Informationsvideos
Information video



Smarte und bequeme Steuerung per App
Smart and convenient control via app

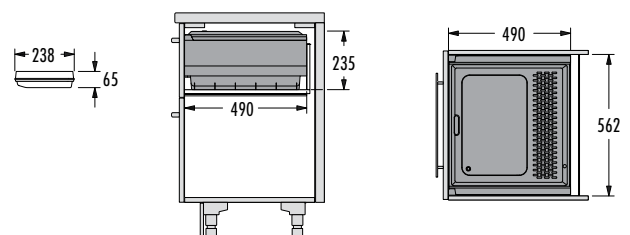
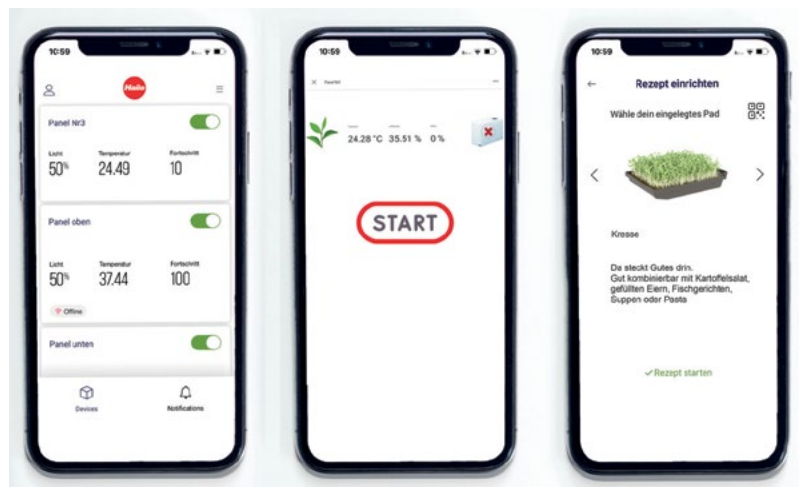

30 cm

40 cm

45 cm

50 cm

60 cm

80 cm

90 cm

Inch



HAILO Haustierstation.

HAILO Pet station.

Tierfütterung und mehr in Küche und Hauswirtschaftsraum.

Pet feeding and more in kitchen and utility room.



Für Schränke ab 400 mm Breite mit Drehtür.

For hinged door cabinets from 400 mm width.

40 CM SWING.



HAILO Haustierstation. HAILO Pet station.



Die HAILO Futterstation für das Haustier verfügt über ein oder zwei Edelstahl-Näpfe, die auf einer abgerundeten Plattform an der Schranktür fixiert sind. Die Plattform lässt sich nach Öffnen der Türe auf den Boden absenken und nach Beendigung der Fütterung direkt wieder hochziehen und wegklappen. Die Futterstation passt an jeden Drehtürenschränk ab 40 cm Breite. Zur Reinigung oder Befüllung können die Näpfe problemlos aus der Station herausgenommen werden.

HAILO Futterstation Hund. HAILO Pet station Dog.

3290001



Anzahl Edelstahl-Futternapf:	1 x 1,8 l
Farbe:	Metallteile silber, Kunststoffteile dunkelgrau
Produktmaße (B x T x H):	292 x 353 x 667 mm
Verpackungsmaße (B x T x H):	560 x 300 x 180 mm
Gewicht mit Verpackung:	1,8 kg

HAILO Futterstation Katze. HAILO Pet station Cat.

3291001

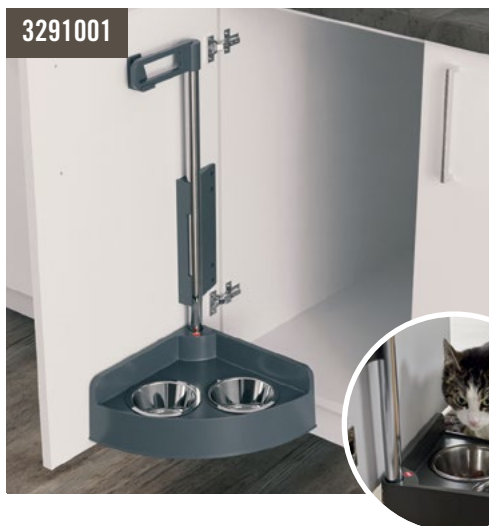

Anzahl Edelstahl-Futternapf:	2 x 0,45 l
Farbe:	Metallteile silber, Kunststoffteile dunkelgrau
Produktmaße (B x T x H):	292 x 353 x 667 mm
Verpackungsmaße (B x T x H):	560 x 300 x 180 mm
Gewicht mit Verpackung:	1,8 kg



Für Schränke ab 400 mm Breite mit Drehtür.

For hinged door cabinets from 400 mm width.

Passend für Schränke
Suitable for cabinets

40 45 50 60 cm

The HAILO feeding station for the pet has one or two bowls (stainless steel) fixed on a rounded platform on the cabinet door.
The platform can be lowered to the floor after the door is opened, and when feeding is finished, it can be pulled up and folded away directly.
The built-in module fits on every hinged door of kitchen cabinets from 40 cm width.
For cleaning or filling, the bowls can be easily removed from the station.

Number of stainless steel bowls: 1 x 1,8 l
Colour: Metal parts silver, Plastic parts dark grey
Product dimensions: (B x T x H): 292 x 353 x 667 mm
Packing dimensions: (B x T x H): 560 x 300 x 180 mm
Weight incl. packing: 1,8 kg



3290001



4 007126 302670

Number of stainless steel bowls: 2 x 0,45 l
Colour: Metal parts silver, Plastic parts dark grey
Product dimensions: (B x T x H): 292 x 353 x 667 mm
Packing dimensions: (B x T x H): 560 x 300 x 180 mm
Weight incl. packing: 1,8 kg



3291001



4 007126 302922

30 cm

40 cm

45 cm

50 cm

60 cm

80 cm

90 cm

Inch

SWING.



HAILO Ablage weiß. *HAILO Shelf white.*

3271151



Ablage (inkl. Kehrset)

Diese Universalablage eignet sich ideal zum Abstellen von Eimern, sonstigen Behältern und vielem mehr. Ein integrierter Haken, unter dem Ablageboard, schafft zusätzlich Aufhängemöglichkeiten für bspw. Tücher und Lappen oder das integrierte Kehr-Set.

Einfache Montage mit nur 4 Schrauben.

Trägermodul, Stahlblech, inklusive Kehr-Set

Farbe: Metallteile weiß

Produktmaße (B x T x H): 289 x 480 x 158 mm
(ohne Kehr-Set) / H 305 mm (mit Kehr-Set)

Verpackungsmaße (B x T x H): 340 x 500 x 125 mm

Gewicht mit Verpackung: 3,1 kg

HAILO Ablage dunkelgrau. *HAILO Shelf dark grey.*

3271811



Ablage (inkl. Kehrset)

Einfache Montage mit nur 4 Schrauben.

Trägermodul, Stahlblech, inklusive Kehr-Set

Farbe: Metallteile dunkelgrau

Produktmaße (B x T x H): 289 x 480 x 158 mm
(ohne Kehr-Set) / H 305 mm (mit Kehr-Set)

Verpackungsmaße (B x T x H): 340 x 500 x 125 mm

Gewicht mit Verpackung: 3,1 kg

Für Schränke mit Drehtür.

For cabinets with hinged door.

Shelf (including sweeping set)

This universal shelf is ideal for storing buckets, other containers, and much more. An integrated hook under the shelf creates additional hanging options, for wipes and cloths, or the integrated sweeping set.

Easy installation with 4 screws only.

Carrier shelf in sheet steel, included sweeping set.

Colour: Metal parts white

Product dimensions (W x D x H): 289 x 480 x 158 mm
(without sweeping set) / H 305 mm (including sweeping set)

Packing dimensions (W x D x H): 340 x 500 x 125 mm

Weight incl. packing 3,1 kg



3271151



4 007126 327345

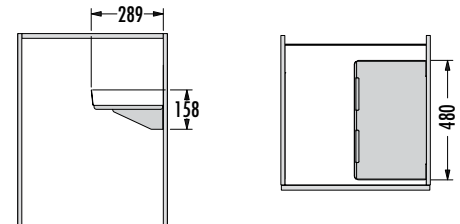

Shelf (including sweeping set)

Easy installation with 4 screws only.

Carrier shelf in sheet steel, included sweeping set.

Colour: Metal parts dark grey

Product dimensions (W x D x H): 289 x 480 x 158 mm
(without sweeping set) / H 305 mm (including sweeping set)

Packing dimensions (W x D x H): 340 x 500 x 125 mm

Weight incl. packing: 3,1 kg



3271811



4 007126 302731

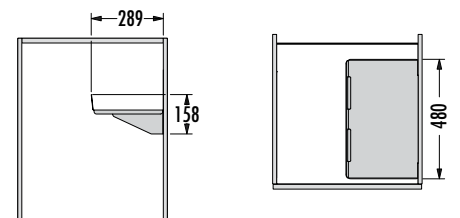

30 cm

40 cm

45 cm

50 cm

60 cm

80 cm

90 cm

Inch



HAILO Pantry Box.

Ideales Aufbewahrungskonzept für Lebensmittel in der Küche.

The ideal storage concept for groceries in the kitchen.



Einsatz für Schubkästen mit 600 mm Breite.

For common drawer cabinets of 600 mm width.

60 CM INSET.

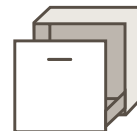

HAILO Pantry Box.



Für Unterschränke 600 mm Breite

Inklusive einer Tragebox

Inklusive Holzrost für Backwaren und Kunststoffrost für Gemüse

Montageart:

Schubkasteneinsatz für alle handelsüblichen

Schubkastensysteme

(Seitenwandstärke 16 mm)

Farbe:

Kunststoffteile weiß, dunkelgrau

Produkt-Maße (T x H):

490 x 232 mm

Schubkasten Nenntiefe:

500 mm

Verpackungsmaße (B x T x H):

730 x 600 x 330 mm

Gewicht mit Verpackung:

9,6 kg



Einsatz für Schubkästen mit 600 mm Breite.

For common drawer cabinets of 600 mm width.

For 600 mm wide drawer-cabinets

Including Carry-Box (transportable plastic container with handle)

Including wooden grid for bakery products and plastic grid for vegetables

Type of installation: for any common standard-drawers
in boxed kitchen- and base-cabinets
(with sidewall thickness from 16 mm)

Colour: Plastic parts white, dark-grey

Product dimensions (D x H): 490 x 232 mm

Nominal depth: 500 mm

Packing dimensions (W x D x H): 730 x 600 x 330 mm

Weight incl. packing: 9,6 kg



3960601



4 007126 396044

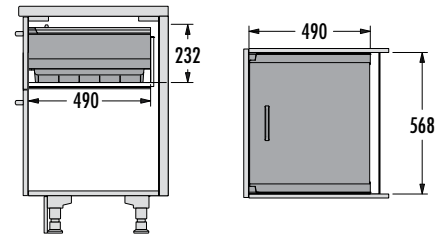

30 cm

40 cm

45 cm

50 cm

60 cm

80 cm

90 cm

Inch



HAILO Handtuchhalter.

HAILO Towel rail.

Die praktischen, platzsparenden Handtuchhalter.

The practical, space-saving towel rails.

HAILO Secco S Handtuchhalter dunkelgrau. *HAILO Towel Rail dark grey.*



3151101

Modell:	Secco S
Haltestangen:	1
Produkt-Maße:	450 x 200 x 20 mm
Haltestangen Länge:	450 mm
Farbe:	Kunststoffteile dunkelgrau
Gewicht:	0,4 kg
Verpackungsmaße (B x T x H):	460 x 210 x 30 mm

NEW

HAILO Secco S Handtuchhalter. *HAILO Towel Rail.*

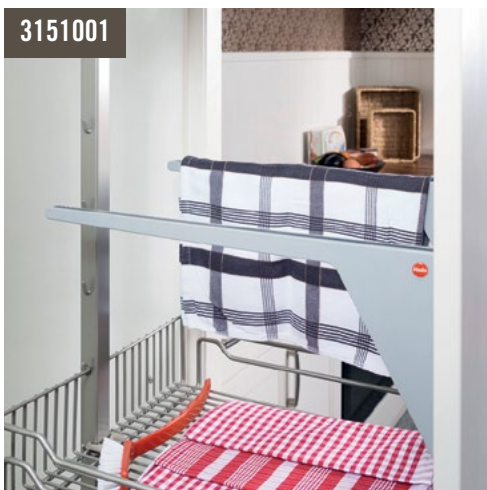

3151001

Modell:	Secco S
Haltestangen:	1
Produkt-Maße:	450 x 200 x 20 mm
Haltestangen Länge:	450 mm
Farbe:	Kunststoffteile hellgrau
Gewicht:	0,4 kg
Verpackungsmaße (B x T x H):	460 x 210 x 30 mm

HAILO Handtuchhalter mit 2 Haltestangen. *HAILO Towel Rail with 2 bars.*



3142901

Modell:	Handtuchhalter 2-teilig
Ausziehstangen:	2
Produktmaße (B x T x H):	119 x 86 x 430 mm
Ausziehbar von - bis:	430-755 mm
Farbe:	Metall- und Kunststoffteile weiß
Gewicht Verpackungseinheit:	6 kg
Verpackungsmaße (B x T x H):	525 x 573 x 278 mm
Verpackungseinheit:	10

Gut betucht.

Well to do.

Model: Secco S
Holding bars: 1 arm
Product dimensions: 450 x 200 x 20 mm
Holding bar, length: 450 mm
Colour: Plastic parts dark grey
Weight: 0,4 kg
Packing dimensions (W x D x H): 460 x 210 x 30 mm

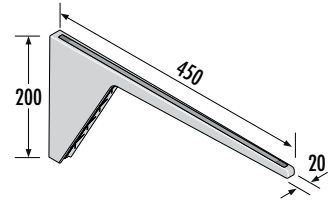

Model: Secco S
Holding bars: 1 arm
Product dimensions: 450 x 200 x 20 mm
Holding bar, length: 450 mm
Colour: Plastic parts light grey
Weight: 0,4 kg
Packing dimensions (W x D x H): 460 x 210 x 30 mm

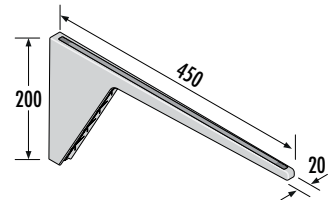

Model: Towel rail, double rail
Pull-out bars: 2 arms
Product dimensions (W x D x H): 119 x 86 x 430 mm
To be extended from - to: 430-755 mm
Colour: Metal and plastic parts white
Weight packing unit: 6 kgs
Packing dimensions (W x D x H): 525 x 573 x 278 mm
Packing unit: 10

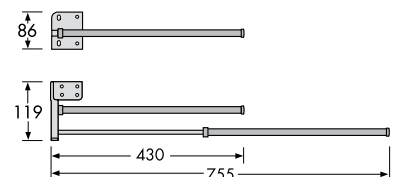

30 cm

40 cm

45 cm

50 cm

60 cm

80 cm

90 cm

Inch

HAILO Handtuchhalter mit 3 Haltestangen. *HAILO Towel Rail with 3 bars.*

3143901



Modell:	Handtuchhalter 3-teilig
Ausziehstangen:	3
Produktmaße (B x T x H):	168 x 86 x 430 mm
Ausziehbar von - bis:	430-755 mm
Farbe:	Metall- und Kunststoffteile weiß
Gewicht Verpackungseinheit:	6,0 kg
Verpackungsmaße (B x T x H):	461 x 414 x 130 mm
Verpackungseinheit:	10

HAILO Handtuchhalter mit 2 Haltestangen. *HAILO Towel Rail with 2 bars.*

3132101



Modell:	Secco mit 2 Haltestangen
Haltestangen:	2
Produktmaße (B x T x H):	122 x 457 x 30 mm
Farbe:	Metallteile Alu, Kunststoffteile dunkelgrau
Gewicht:	300 g
Verpackungsmaße (B x T x H):	455 x 155 x 80 mm

HAILO Handtuchhalter mit 3 Haltestangen. *HAILO Towel Rail with 3 bars.*

3133101



Modell:	Secco mit 3 Haltestangen
Haltestangen:	3
Produktmaße (B x T x H):	184 x 457 x 30 mm
Farbe:	Metallteile Alu, Kunststoffteile dunkelgrau
Gewicht:	420 g
Verpackungsmaße (B x T x H):	455 x 155 x 80 mm

Gut betucht.

Well to do.

Model: Towel rail, triple rail
Pull-out bars: 3 arms
Product dimensions (W x D x H): 168 x 86 x 430 mm
To be extended from - to: 430-755 mm
Colour: Metal and plastic parts white
Weight packing unit: 6,0 kgs
Packing dimensions (W x D x H): 461 x 414 x 130 mm
Packing unit: 10

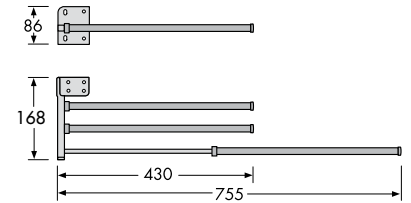

Model: Secco with 2 bars
Holding bars: 2 arms
Product dimensions (W x D x H): 122 x 457 x 30 mm
Colour: Metal parts Alu, Plastic parts dark grey
Weight: 300 g
Packing dimensions (W x D x H): 455 x 155 x 80 mm

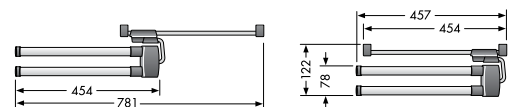

Model: Secco with 3 bars
Holding bars: 3 arms
Product dimensions (W x D x H): 184 x 457 x 30 mm
Colour: Metal parts Alu, Plastic parts dark grey
Weight: 420 g
Packing dimensions (W x D x H): 455 x 155 x 80 mm

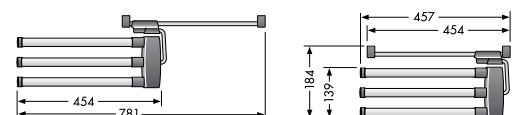

30 cm

40 cm

45 cm

50 cm

60 cm

80 cm

90 cm

Inch



HAILO Deposito.

Optimale Stauraumnutzung in Flachdunstabzugsschränken.

Optimum use of storage space in flat extractor cabinets.

HAILO Deposito Regalsystem. *HAILO Rack System.*

3981651



Flachdunstregal, für 16 mm und 19 mm Seitenwandstärke

Schrankbreite:	600 mm
Seitenwände:	16 mm + 19 mm
Produktmaße (B x T x H):	568-562 x 75 x 43 mm
Verpackungsmaße (B x T x H):	593 x 120 x 60 mm
Monteart:	Seitenwandmontage
Farbe:	Metall- und Kunststoffteile: dunkelgrau
Verpackungseinheit:	2
Gewicht (mit Verpackung):	1,1 kg

HAILO Deposito Regalsystem. *HAILO Rack System.*

3981951



Flachdunstregal, für 16 mm und 19 mm Seitenwandstärke

Schrankbreite:	900 mm
Seitenwände:	16 mm + 19 mm
Produktmaße (B x T x H):	865-862 x 75 x 43 mm
Verpackungsmaße (B x T x H):	859 x 93 x 42 mm
Monteart:	Seitenwandmontage
Farbe:	Metall- und Kunststoffteile: dunkelgrau
Verpackungseinheit:	2
Gewicht (mit Verpackung):	1,7 kg

Systeme für die Stauraumnutzung bis in den letzten Winkel.

Systems for the use of retaining capacity up to the last corner.

Shelf for extractor fan units with 16 and 19 mm side wall thickness

Cabinet width:	600 mm
Side wall thickness:	16 mm + 19 mm
Product dimensions (W x D x H):	568-562 x 75 x 43 mm
Packing dimensions (W x D x H):	593 x 120 x 60 mm
Kind of installation:	side wall mounting
Colour:	Metal and plastic parts: dark-grey
Packing unit:	2 each per carton
Weight incl. packing:	1,1 kg



3981651



4 007126 301024

Shelf for extractor fan units with 16 and 19 mm side wall thickness

Cabinet width:	900 mm
Side wall thickness:	16 mm + 19 mm
Product dimensions (W x D x H):	865-862 x 75 x 43 mm
Packing dimensions (W x D x H):	859 x 93 x 42 mm
Kind of installation:	side wall mounting
Colour:	Metal and plastic parts: dark-grey
Packing unit:	2 each per carton
Weight incl. packing:	1,7 kg



3981951



4 007126 301031

30 cm

40 cm

45 cm

50 cm

60 cm

80 cm

90 cm

Inch



HAILO Vario.

Leicht zu montierendes Modul für schnellen Zugriff auf Küchenutensilien.

Easy-to-install module for quick access to kitchen utensils.



Für Schränke ab 300 mm Breite mit Drehtür.

For hinged door cabinets from 300 mm width.

30 CM SWING.

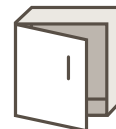

HAILO Vario Einzelauszug. *HAILO Single pull-out Tray.*

3920001



Der Einzelauszug nutzt sogar den Raum über den Abfalltrennsystemen.

Farbe:	Metallteile silberfarben, Alu eloxiert/Kunststoffteile dunkelgrau
Einbau-Maße:	ab 200 mm Schrankbreite
Produktmaße (B x T x H):	155 x 480 x 173 mm
Montageart:	Seitenwandmontage, Rechts-/Linksmontage
Verpackungsmaße (B x T x H):	498 x 188 x 165 mm
Gewicht mit Verpackung:	3,1 kg

HAILO Vario.

3902001



Das Ordnungssystem Combi Vario nutzt die kleinste Nische als Stauraum.

Montageart:	Seitenwandmontage, Rechts-/Linksmontage
Farbe:	Metallteile silberfarben, Alu eloxiert/Kunststoffteile dunkelgrau
Einbau-Maße:	ab 300 mm Schrankbreite
Produktmaße (B x T x H):	158 x 483 x 481 mm
Verpackungsmaße (B x T x H):	505 x 170 x 495 mm
Gewicht mit Verpackung:	5,8 kg

HAILO Vario.

3903001



Montageart:	Seitenwandmontage, Rechts-/Linksmontage
Farbe:	Metallteile silberfarben, Alu eloxiert/Kunststoffteile dunkelgrau
Einbau-Maße:	ab 300 mm Schrankbreite
Produktmaße (B x T x H):	158 x 483 x 481 mm
Verpackungsmaße (B x T x H):	505 x 170 x 495 mm
Gewicht mit Verpackung:	6,45 kg

HAILO Vario.

3909001



Montageart:	Seitenwandmontage, Rechts-/Linksmontage
Farbe:	Metallteile silberfarben, Alu eloxiert/Kunststoffteile dunkelgrau
Einbau-Maße:	ab 300 mm Schrankbreite
Produktmaße (B x T x H):	158 x 483 x 481 mm
Verpackungsmaße (B x T x H):	505 x 170 x 495 mm
Gewicht mit Verpackung:	5,5 kg

Für Schränke ab 300 mm Breite mit Drehtür.

For hinged door cabinets from 300 mm width.

The single pull-out Vario-Tray uses even the space above the waste separation system.

Colour: Metal parts silver-coloured, Aluminium anodized, Plastic parts dark-grey
Built-in dimensions: from 200 mm Cabinet width
Product dimensions (W x D x H): 155 x 480 x 173 mm
Type of installation: Right-/Left-hand sidewall
Packing dimensions (W x D x H): 160 x 480 x 180 mm
Weight incl. packing: 3,1 kg



3920001



4 007126 392008

The Vario-Organizer System uses even the smallest space for storage.

Type of installation: Right-/Left-hand sidewall
Colour: Metal parts silver-coloured, Aluminium anodized/Plastic parts dark-grey
Built-in dimensions: from 300 mm Cabinet width
Product dimensions (W x D x H): 158 x 483 x 481 mm
Packing dimensions (W x D x H): 505 x 170 x 495 mm
Weight incl. packing: 5,8 kg



3902001



4 007126 390202

Type of installation: Right-/Left-hand sidewall
Colour: Metal parts silver-coloured, Aluminium anodized/Plastic parts dark-grey
Built-in dimensions: from 300 mm Cabinet width
Product dimensions (W x D x H): 158 x 483 x 481 mm
Packing dimensions (W x D x H): 505 x 170 x 495 mm
Weight incl. packing: 6,45 kg



3903001



4 007126 390301

Type of installation: Right-/Left-hand sidewall
Colour: Metal parts silver-coloured, Aluminium anodized/Plastic parts dark-grey
Built-in dimensions: from 300 mm Cabinet width
Product dimensions (W x D x H): 158 x 483 x 481 mm
Packing dimensions (W x D x H): 505 x 170 x 495 mm
Weight incl. packing: 5,5 kg



3909001



4 007126 390905

30 cm

40 cm

45 cm

50 cm

60 cm

80 cm

90 cm

Inch



HAILO Carry.

Der Begleiter im Spülenunterschrank.

The companion in the sink base unit.



Für Schränke ab 400 mm Breite mit Drehtür.

For hinged door cabinets from 400 mm width.

40 CM SWING.

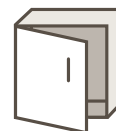

HAILO Carry.



3950001

Der HAILO Carry ist ausgestattet mit zwei Tragekörben, aufsteckbar auf Auszugssystem mit Selbsteinzug und Dämpfung – schließt sanft und leise.

Durch einfaches herausziehen der mobilen Utensilienkörbe können z.B. Putzmittel zu ihrem Einsatzort getragen werden. Schiene gedämpft, abgedeckt

Farbe:	hellgrau
Einbau-Maße (B x T x H):	249 x 459 x 410 mm
Verpackungsmaße (B x T x H):	504 x 260 x 420 mm
Gewicht mit Verpackung:	6 kg

HAILO Carry

Der Begleiter im Spülenunterschrank. kombinierbar mit unterschiedlichen HAILO-Produkten, z. B. mit unseren bodenmontierten Mülltrennsystemen.



HAILO Carry2.



3950551

NEW

Praktischer Tragekorb für Spülmittel und mehr – ideale Ergänzung zum Abfalltrennsystem im Spülenschrank.

Farbe:	Kunststoffteile dunkelgrau
Produktmaße (B x T x H):	403 x 140 x 340 mm

Mobil und flexibel – Tragekörbe stapelbar (für Einlagerung und Transport)
Stabiler Kunststoff – gute Haptik am Tragegriff
Putzmittel und Co. gut verstaut und schnell griffbereit
Geeignet zur Kombination mit Abfalltrennsystem, in Schränken ab 600 mm Breite





Für Schränke ab 400 mm Breite mit Drehtür.

For hinged door cabinets from 400 mm width.

Passend für Schränke
Suitable for cabinets

40 45 50 60 cm

The HAILO Carry comes with carrying Baskets easily removable, transportable, and attachable.
 Pullout tray with low-noise, full-extension, self-closing & -dampening slides.
 The transportable, utensil Baskets for any cleansers, agents, etc., may be carried to the spot.
 Damped and covered slides
 colour: light grey
 Built-In dimensions (W x D x H): 249 x 459 x 410 mm
 Packing dimensions (W x D x H): 504 x 260 x 420 mm
 Weight incl. packing: 6 kg

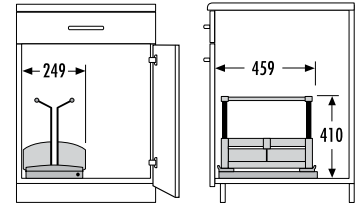

HAILO Carry

The helper in your sink unit, may be combined with various HAILO products, such as bottom-mount recycling systems.

Passend für Schränke
Suitable for cabinets

40 45 50 60 cm

Practical carrying basket for detergents and more – ideal complement to the waste separation system in the sink cabinet.

Colour: Plastic parts dark grey
Product dimensions (W x D x H): 403 x 140 x 340 mm

Mobile and flexible – Carrying baskets stackable (for storage and transport)
Sturdy plastic – good haptics at the carrying handle
Cleaning agents and co. well stored and quickly at hand
Suitable for combination with waste separation system, in cabinets as of 600 mm width



30 cm

40 cm

45 cm

50 cm

60 cm

80 cm

90 cm

Inch



Funktionssysteme.

Functional systems.

30 cm

40 cm

45 cm

50 cm

60 cm

80 cm

90 cm

Inch



208 - 211
Libero 3.0.



212 - 213
Kick and go.



214 - 217
Ausziehtische.
Pull-out tables.



218 - 221
Stepfix.



HAILO Libero 3.0.

Laser-Sensoröffner für automatisches Öffnen aller Auszugssysteme.

Laser sensor opener for automatic opening of pull-out-systems of all kind.

HAILO Libero® 3.0.

3697301



AUSZÜGE ÖFFNEN – AUTOMATISCH UND KOMFORTABEL

HAILO Libero 3.0 – Hands Free Opener

Der Laser-Sensoröffner von HAILO für ein automatisches, komfortables Öffnen aller Abfalltrennsysteme mit Frontanbindung und aller Auszugssysteme.

Einfache Bedienung durch Fußsensor und / oder optionale Sprachsteuerung.

Für den meist genutzten Auszug in der Küche, dem Spülen- bzw. Müllschrank, glänzt HAILO – Libero mit folgenden Vorteilen:



Für Unterschränke von 300 mm bis 1200 mm Breite

Kein unbeabsichtigtes Öffnen

Montage im vorderen Bereich des Schrankbodens

Kann einfach nachgerüstet werden

Niedervoltgerät (5V), mit USB-C Buchse

Stromversorgung über herkömmliche Steckdosen 110 - 230 V,

mit 2 m Kabel USB-C / USB Stecker inkl. 5 V, 2 A Netzteil

und internationalen Adapter

Einfache Bedienung durch neuen Laser-Fußsensor und / oder Sprachsteuerung

Einstellungen und Konfigurationen über Webbrowser

Integrierte LED Auffindbeleuchtung, dimmbar, abschaltbar

Auswurfstärke einstellbar, Sensor Empfindlichkeit einstellbar

Intelligente Steuerung, erkennt Hindernisse dank Rutschkupplung

Tropfwassergeschützt nach IP 21 Zertifizierung

Mit europäischen, britischen, australischen und nordamerikanischen

Zertifizierungen. Kompatibel zu Alexa Sprachsteuerungssystemen

Entwicklung und Herstellung in Deutschland

Abmessungen (B x T x H): 157 mm x 300 mm x 33 mm

Verpackungsmaße (B x T x H): 325 x 235 x 55 mm

WEEE-Reg.-Nr.: DE 60802808

Gewicht (mit Verpackung): 0,95 kg

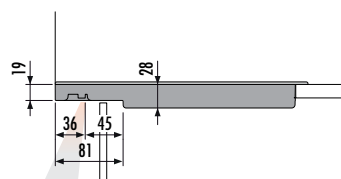
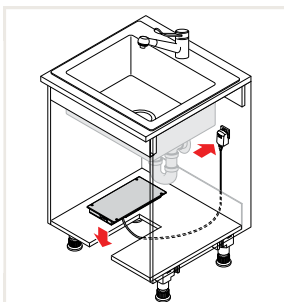

Kompatibel mit:
Compatible with:



Automatischer Türöffner für alle Auszugssysteme.

Automatic Door-Opener for Pull-Out-Systems of all kind.

Open Pullouts and Drawers automatically and easily.

HAILO Libero 3.0 – Hands Free Opener

HAILO's electronic sensor-opener Libero 3.0 for front-mount-doors and drawers offers an automatic, comfortable hands-free opening of all waste-recycling-systems with attached door-panel, and of any common, also damped, drawer-mounted systems.

Easy operation by laser-sensor and / or optionally voice activated.

For the most frequently opened pull-out in the kitchen, the waste-recyclingsystem, the HAILO Libero offers the following advantages:

For base cabinets from 300 mm to 1200 mm (12 in. to 48 in.) widths
No unintended opening

Mounts in forward section of bottom-panel

Can also easily be retrofitted

Low Voltage device, 5 V, 2 A input, comes with USB-C socket

Power supply by electrical driver for 110 V thru 230 V outlets,

with 2 m USB-C / USB cable and international adapters

Easy operation by Laser-Sensor and / or optional voice activation

Integrated location LED lighting, may be dimmed and switched off

Push-out force adjustable, detection-range adjustable

Optional Settings and Fine Tuning Adjustments via Web Browser

Intelligent controls, identifies obstacles thanks to friction clutch

Protected against dripping water according to IP 21 certification

Comes with European, British, North American and Australian

Certifications

Optional opening via "Alexa" smart speaker

Developed and Made in Germany

Dimensions (W x D x H): 157 mm x 300 mm x 33 mm

6-1/8 in. x 11- 3/4 in. x 1- 1/4 in.

Packing dimensions (W x D x H): 325 x 235 x 55 mm

WEEE-Reg.-No.: DE 60802808

Weight incl. packing: 0,95 kg



3697301



4 007126 301000



**Öffnen per Fuß oder Sprachsteuerung.
Opening by foot or voice activation.**



Youtube:

Informationsvideos Information video

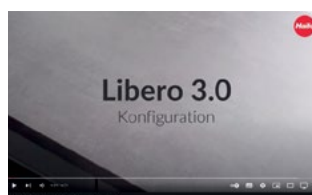

30 cm

40 cm

45 cm

50 cm

60 cm

80 cm

90 cm

Inch

HAILO Kick and go Fußhebel. *HAILO Foot Pedal.*

3691301



**Fußhebel "Kick and go" für Frontauszüge
und untere Schubkästen**

HAILO Kick and go Türöffner. *HAILO Door-Opener.*

3692021



Türöffner für Drehtüren

Für Drehtüren ab 300 mm
Federdruckelement aus Kunststoff, mit Fußhebel,
Magnetteil, Metallmagnethalteplatte.

Automatischer Türöffner für Auszugssysteme.

Automatic Door-Openers/ Toe-Kicks for recycling-systems.

Foot Pedal "Kick and go" for Front mounted door and lower drawer



3691301



4 007126 369123

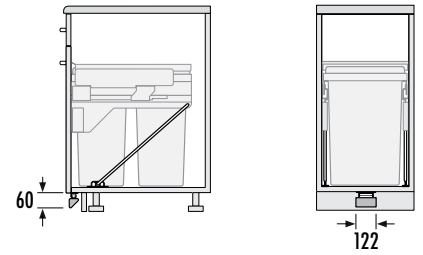

Door-Opener for hinged doors.

For hinged doors from 300 mm, with magnetic catch, counter-plate, and spring-loaded roller arm.



3692021



4 007126 369222

30 cm

40 cm

45 cm

50 cm

60 cm

80 cm

90 cm

Inch



HAILO Ausziehtische.

HAILO Pull-out tables.

Flexible Platzlösungen in der Küche.

Flexible space solutions in the kitchen.

HAILO Rapid für 600er Breite. *HAILO Rapid for width 600 mm.*

3845601



Modell:	3845601
Dekor:	Weiß
Seitenwände:	16 mm + 19 mm
Einbau ab Schrankbreite:	600 mm
Einbau-Maße (B x T x H):	561 x 490 x 120 mm
Tischplatte/Ausziehfläche (B x L):	521 x 800 mm
Belastbar bis:	100 kg
Gewicht:	11 kg
Verpackungsmaße (B x T x H):	135 x 510 x 575 mm
Stufenlos ausziehbar	

3845121



Modell:	3845121
Dekor:	Edelstahl
Seitenwände:	16 mm + 19 mm
Einbau ab Schrankbreite:	600 mm
Einbau-Maße (B x T x H):	561 x 490 x 120 mm
Tischplatte/Ausziehfläche (B x L):	521 x 800 mm
Belastbar bis:	100 kg
Gewicht:	11 kg
Verpackungsmaße (B x T x H):	135 x 510 x 575 mm
Stufenlos ausziehbar	

Auszugsweise Platz.

Pulled out Space.

Type: 3845601
 Dekor: „white“
 Side wall thickness: 16 mm + 19 mm
 Min. cabinet width reqd.: 600 mm
 Built-in dimensions (B x T x H): 561 x 490 x 120 mm
 Table extended (W x L): 521 x 800 mm
 Load bearing capacity: 100 kg
 Weight: 11 kg
 Packing dimensions (W x D x H): 135 x 510 x 575 mm
 Continuously extendible



3845601



4 007126 384461

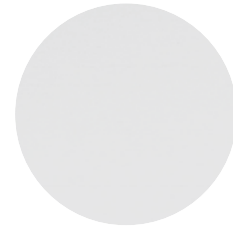

30 cm

40 cm

45 cm

50 cm

60 cm

Type: 3845121
 Dekor: „steel/alubrushed“
 Side wall thickness: 16 mm + 19 mm
 Min. cabinet width reqd.: 600 mm
 Built-in dimensions (B x T x H): 561 x 490 x 120 mm
 Table extended (W x L): 521 x 800 mm
 Load bearing capacity: 100 kg
 Weight: 11 kg
 Packing dimensions (W x D x H): 135 x 510 x 575 mm
 Continuously extendible



3845121



4 007126 384546

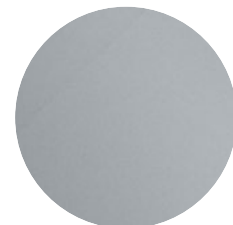

80 cm

90 cm

Inch



HAILO Stepfix.

Der platzsparende Einbau-Klapptritt.

The space-saving built-in folding step.

30 cm

40 cm

45 cm

50 cm

60 cm

80 cm

90 cm

Inch

HAILO Stepfix®.

4410001



Einbaumaße:	B x T x H, 403 x 98 x 470 mm (zusammengeklappt)
Produktmaße (B x T x H):	403 x 387 x 380 mm (aufgestellt)
Farbe:	Metall- & Kunststoffteile anthrazit
Tritthöhe:	350 mm
Verpackungsmaße (B x T x H):	403 x 470 x 100 mm
Gewicht:	3,9 kg

HAILO Wandhalter für Stepfix. *HAILO Universal bracket for Stepfix.*

4495001



Farbe:	Metallteile dunkelgrau
Produktmaße (B x T x H):	144 x 37 x 30 mm
Verpackungsmaße (B x T x H):	197 x 150 x 97 mm (10 VE):
Gewicht:	0,2 kg
Verpackungseinheit:	10

HAILO Sockelblendenhalter für Stepfix. *HAILO Plinth bracket for Stepfix.*

4496001



Farbe:	Metallteile glanzverzinkt
Produktmaße (B x T x H):	357 x 128 x 41 mm
Verpackungsmaße (B x T x H):	445 x 190 x 85 mm (10 VE):
Gewicht inkl. Verpackung:	0,2 kg
Verpackungseinheit:	10



Der platzsparende Einbau-Klapptritt.

The space-saving built-in folding step.

Built-In dimensions: *W x D x H, 403 x 98 x 470mm*
(folded up)

Product dimensions (W x D x H): 403 x 387 x 380 mm
(set up)

Colour: Metal- & Plastic parts anthracite

Stepping height: 350 mm

Packing dimensions (W x D x H): 403 x 470 x 100 mm

Weight: 3,9 kg

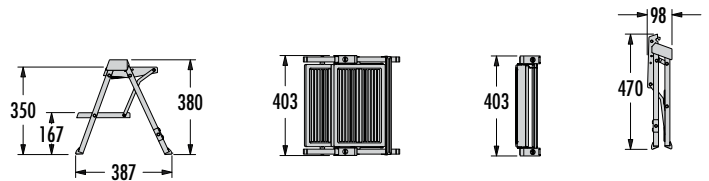

Colour: Metal parts dark-grey

Product dimensions (W x D x H): 144 x 37 x 30 mm

Packing dimensions (W x D x H): 197 x 150 x 97mm
(10 units):

Weight: 0,2 kg

Packing unit: 10



Colour: Metal parts zinc-coated

Product dimensions (W x D x H): 357 x 128 x 41 mm

Packing dimensions (B x T x H): 445 x 190 x 85 mm
(10 VE)

Weight incl. packing: 0,2 kg

Packing unit: 10



30 cm

40 cm

45 cm

50 cm

60 cm

80 cm

90 cm

Inch



Hauswirtschaftsraum.

Utility room.

30 cm

40 cm

45 cm

50 cm

60 cm

80 cm

90 cm

Inch



224 - 239
Ordnungsmodule.
Organizer modules.



240 - 249
Laundry Carrier.



HAILO Ordnungsmodule.

HAILO organizer modules.

Praktische Module zur Aufbewahrung.

Practical modules for storage.



Für Schränke mit Drehtür.

For cabinets with hinged door.

60 CM SWING.



HAILO Universaltablar weiß. *HAILO Universal Pullout white.*

3271351



Hinweis: Das Universaltablar ist nur für 60er Schränke mit 16 mm Seitenwandstärke geeignet!

Das Universaltablar lässt sich mittels hochwertiger Auszugsschienen herausziehen und eignet sich ideal als Depot für Staubsauger und andere größere Gegenstände. Durch die direkte Montage der Schienen an der Seitenwand des Schrankes ist das Universaltablar hoch belastbar. Auch geeignet zur Lagerung von Getränkekisten.

2 Auszugsschienen, 1 Abstandhalter

Farbe:	Metall- & Kunststoffteile weiß
Belastbar:	bis 40 kg
Produktmaße (B x T x H):	568 x 510 x 71 mm (ohne Wäschekorb) / H 314 mm (mit optional erhältlichem Wäschekorb)
Verpackungsmaße (B x T x H):	550 x 535 x 195 mm
Gewicht mit Verpackung:	6,7 kg



HAILO Universaltablar dunkelgrau. *HAILO Universal Pullout dark grey.*

3271831

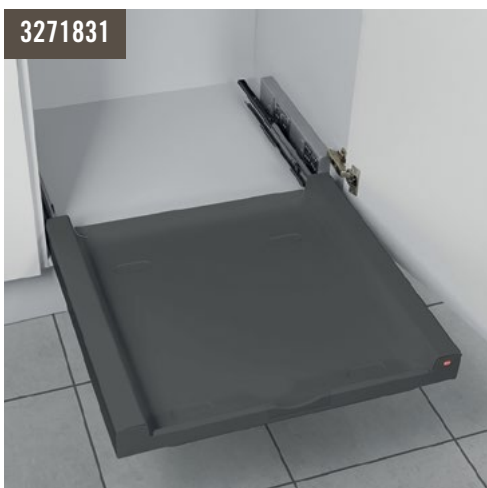

Hinweis: Das Universaltablar ist nur für 60er Schränke mit 16 mm Seitenwandstärke geeignet!

Das Universaltablar lässt sich mittels hochwertiger Auszugsschienen herausziehen und eignet sich ideal als Depot für Staubsauger und andere größere Gegenstände. Durch die direkte Montage der Schienen an der Seitenwand des Schrankes ist das Universaltablar hoch belastbar. Auch geeignet zur Lagerung von Getränkekisten.

2 Auszugsschienen, 1 Abstandhalter

Farbe:	Metall- & Kunststoffteile dunkelgrau
Belastbar:	bis 40 kg
Produktmaße (B x T x H):	568 x 510 x 71 mm (ohne Wäschekorb) / H 314 mm (mit optional erhältlichem Wäschekorb)
Verpackungsmaße (B x T x H):	550 x 535 x 195 mm
Gewicht mit Verpackung:	6,7 kg

HAILO Set Universaltablar. *HAILO Set Universal Pullout.*

3272002



**Set bestehend aus Wäschekorb weiß (Artnr. 3271381)
+ Universaltablar dunkelgrau (Artnr. 3271831)**

Farbe:	Metallteile dunkelgrau, Kunststoffteile dunkelgrau, weiß
Produktmaße (B x T x H):	568 x 510 x 314 mm
Seitenwandstärke:	16 mm
Passend für Schrankbreiten:	60 cm
Belastbarkeit:	bis 40 kg
Gewicht:	9,3 kg

Für 600 mm breite Schränke mit Drehtür.

For 600 mm wide cabinets with hinged door.

Note: The universal pullout is only suitable for 60 cm cabinets with 16 mm sidewall thickness!

The universal pullout can be pulled out by synchronized, covered overtravel slides and is ideally suited for bottle crates, vacuum cleaners, and other larger items. By the direct mounting of the rails on the sidewall of the cabinet, the universal pullout is highly resilient.

2 synchronized, covered overtravel slides, 1 spacer-block (for hinges side)

Colour: Metal & plastic parts white

Load bearing capacity: 40 kg

Product dimensions (W x D x H): 568 x 510 x 71 mm (without laundry basket) / H 314 mm (including optional laundry basket)

Packing dimensions (W x D x H): 550 x 535 x 195 mm

Weight incl. packing: 6,7 kg



3271351



4 007126 327314

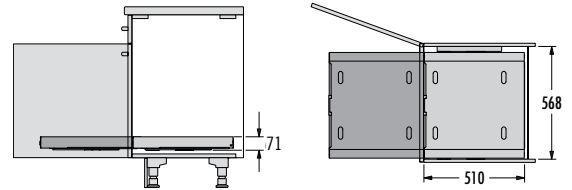

Note: The universal pullout is only suitable for 60 cm cabinets with 16 mm sidewall thickness!

The universal pullout can be pulled out by synchronized, covered overtravel slides and is ideally suited for bottle crates, vacuum cleaners, and other larger items. By the direct mounting of the rails on the sidewall of the cabinet, the universal pullout is highly resilient.

2 synchronized, covered overtravel slides, 1 spacer-block (for hinges side)

Colour: Metal & plastic dark grey

Load bearing capacity: 40 kg

Product dimensions (W x D x H): 568 x 510 x 71 mm (without laundry basket) / H 314 mm (including optional laundry basket)

Packing dimensions (W x D x H): 550 x 535 x 195 mm

Weight incl. packing: 6,7 kg



3271831



4 007126 302755

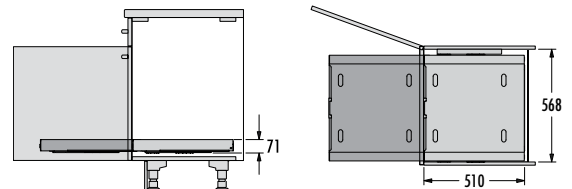

Set consisting of laundry basket white (item no. 3271381)

+ Universal Pullout, dark grey (item no. 3271831)

Colour: Metal parts dark grey, Plastic parts dark grey, white

Product dimensions (W x D x H): 568 x 510 x 314 mm

Side-wall thickness: 16 mm

Suitable for cabinet width: 60 cm

Load capacity: up to 40 kg

Weight incl. packing: 9,3 kg



3272002



4 007126 302908

30 cm

40 cm

45 cm

50 cm

60 cm

80 cm

90 cm

Inch

60 CM SWING.

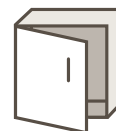

HAILO Set Universaltablar. *HAILO Set Universal Pullout.*

3271002



**Set bestehend aus Wäschekorb blau (Artnr. 3271361)
+ Universaltablar weiß (Artnr. 3271351)**

Farbe:	Metallteile weiß, Kunststoffteile weiß, blau
Produktmaße (B x T x H):	568 x 510 x 314 mm
Seitenwandstärke:	16 mm
Passend für Schrankbreiten:	60 cm
Belastbarkeit:	bis 40 kg
Gewicht:	9,3 kg

HAILO Wäschekorb. *HAILO Laundry basket.*

3271361



Farbe:	Kunststoffteile blau oder weiß
Produktmaße (B x T x H):	520 x 462 x 304 mm
Verpackungsmaße (B x T x H):	550 x 535 x 375 mm
Gewicht mit Verpackung:	2,6 kg
Passgenau für HAILO Universaltablar	



3271381

HAILO Set Shoe Rack.

3272000



**Praktisches Einbaumodul zur Aufbewahrung von Schuhen.
Set bestehend aus Shoe Rack weiß (Artnr. 3271661)
und Universaltablar dunkelgrau (Artnr. 3271831)**

Farbe:	Metallteile weiß + dunkelgrau
Seitenwandstärke:	16 mm
Belastbarkeit:	bis 40 kg
Passend für Schrankbreiten:	60 cm
Produktmaße (B x T x H):	568 x 510 x 173 mm
Gewicht:	10,5 kg

Für 600 mm breite Schränke mit Drehtür.

For 600 mm wide cabinets with hinged door.

**Set consisting of laundry basket blue (item no. 3271361)
+ universal pullout white (item no. 3271351)**

Colour: Metal parts white, Plastic parts white, blue
Product dimensions (W x D x H): 568 x 510 x 314 mm
Side-wall thickness: 16 mm
Suitable for cabinet width: 60 cm
Load capacity: up to 40 kg
Weight incl. packing: 9,3 kg



3271002

4 007126 302915

Colour: Plastic parts blue or white
Product dimensions (W x D x H): 520 x 462 x 304 mm
Packing dimensions (W x D x H): 550 x 535 x 375 mm
Weight incl. packing: 2,6 kg
Custom-fit for HAILO universal pullout



3271361

4 007126 327321

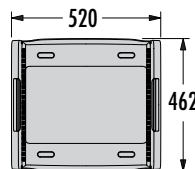

3271381

4 007126 301055

**Practical built-in module for storing shoes.
Add-on metal-rack white (3271661)
incl. universal pullout dark grey (3271831)**

Color metal parts: white + dark grey
Side-wall thickness: 16 mm
Load capacity: up to 40 kg
Suitable for cabinet width: 60 cm
Product dimensions (W x D x H): 568 x 510 x 173 mm
Weight incl. packing: 10,5 kg



3272000

4 007126 302892

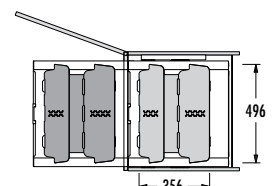
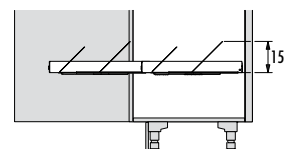

30 cm

40 cm

45 cm

50 cm

60 cm

80 cm

90 cm

Inch

60 CM SWING.

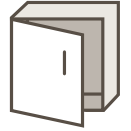

HAILO Set Shoe Rack.

3271000



Praktisches Einbaumodul zur Aufbewahrung von Schuhen.

Set bestehend aus Shoe Rack weiß (Artnr. 3271661) und Universaltablar weiß (Artnr. 3271351)

Farbe:	Metallteile weiß
Seitenwandstärke:	16 mm
Belastbarkeit:	bis 40 kg
Passend für Schrankbreiten:	60 cm
Produktmaße (B x T x H):	568 x 510 x 173 mm
Gewicht:	10,5 kg

HAILO Shoe Rack.

3271661



Metall-Rack zum Aufsatz auf Universaltablar (3271351 und 3271831).

Ideal zum Lagern von Schuhen.

Farbe:	Metallteile weiß
Systemtiefe:	356 mm
Produktmaße (B x T x H):	496 x 356 x 158 mm
Verpackungsmaße (B x T x H):	510 x 430 x 245 mm
Gewicht mit Verpackung:	3,8 kg

HAILO Ablage weiß. HAILO Shelf white.

3271151



Ablage (inkl. Kehrset)

Diese Universalablage eignet sich ideal zum Abstellen von Eimern, sonstigen Behältern und vielem mehr. Ein integrierter Haken, unter dem Ablageboard, schafft zusätzlich Aufhängemöglichkeiten für bspw. Tücher und Lappen oder das integrierte Kehr-Set.

Einfache Montage mit nur 4 Schrauben. Trägermodul, Stahlblech, inklusive Kehr-Set

Farbe:	Metallteile weiß
Produktmaße (B x T x H):	289 x 480 x 158 mm (ohne Kehr-Set) / H 305 mm (mit Kehr-Set)
Verpackungsmaße (B x T x H):	340 x 500 x 125 mm
Gewicht mit Verpackung:	3,1 kg

Für 600 mm breite Schränke mit Drehtür.

For 600 mm wide cabinets with hinged door.

Practical built-in module for storing shoes.

Add-on metal-rack white (3271661) incl. universal pullout white (3271351)

Color metal parts:	white
Side-wall thickness:	16 mm
Load capacity:	up to 40 kg
Suitable for cabinet width:	60 cm
Packing dimensions (W x D x H):	568 x 510 x 173 mm
Weight incl. packing:	10,5 kg

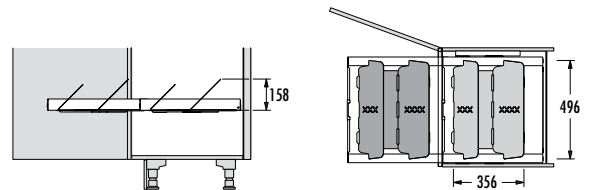

Add-on metal-rack for universal pullout (3271351 and 3271831). Ideal for storing shoes.

Colour:	Metal parts white
System-depth:	356 mm
Packing dimensions (W x D x H):	496 x 356 x 158 mm
Packing dimensions (W x D x H):	510 x 430 x 245 mm
Weight incl. packing:	3,8 kg

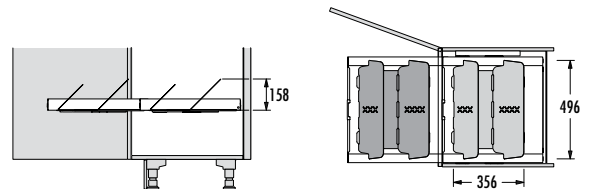

Shelf (including sweeping set)

This universal shelf is ideal for storing buckets, other containers, and much more. An integrated hook under the shelf creates additional hanging options, for wipes and cloths, or the integrated sweeping set.

Easy installation with 4 screws only. Carrier shelf in sheet steel, included sweeping set.

Colour:	Metal parts white
Product dimensions (W x D x H):	289 x 480 x 158 mm (without sweeping set) / H 305 mm (including sweeping set)
Packing dimensions (W x D x H):	340 x 500 x 125 mm
Weight incl. packing :	3,1 kg

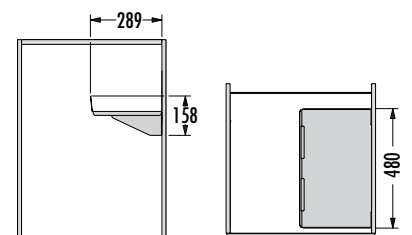

30 cm

40 cm

45 cm

50 cm

60 cm

80 cm

90 cm

Inch

SWING.

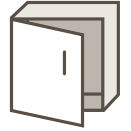

HAILO Ablage dunkelgrau. *HAILO Shelf dark grey.*

3271811



Ablage (inkl. Kehrset)

Diese Universalablage eignet sich ideal zum Abstellen von Eimern, sonstigen Behältern und vielem mehr. Ein integrierter Haken, unter dem Ablageboard, schafft zusätzlich Aufhängemöglichkeiten für bspw. Tücher und Lappen oder das integrierte Kehr-Set.

Einfache Montage mit nur 4 Schrauben.

Trägermodul, Stahlblech, inklusive Kehr-Set

Farbe: Metallteile dunkelgrau

Produktmaße (B x T x H): 289 x 480 x 158 mm (ohne Kehr-Set) /
H 305 mm (mit Kehr-Set)

Verpackungsmaße (B x T x H): 340 x 500 x 125 mm

Gewicht mit Verpackung: 3,1 kg

HAILO Besen-/ Wischerhalter weiß. *HAILO Broom/Wiper Holder white.*

3271251



Besen-/Wischerhalter schafft Platz für die oft sperrigen Besen, Wischer, Schrubber usw. Sauber aufgehängt und sofort griffbereit!

Einfache Montage mit nur 4 Schrauben

Trägermodul, Stahlblech

Farbe: Metallteile weiß

Produktmaße (B x T x H): 137 x 352 x 262 mm

Verpackungsmaße (B x T x H): 140 x 375 x 290 mm

Gewicht mit Verpackung: 1,8 kg



HAILO Besen-/ Wischerhalter dunkelgrau. *HAILO Broom/Wiper Holder dark grey.*

3271821



Besen-/Wischerhalter schafft Platz für die oft sperrigen Besen, Wischer, Schrubber usw. Sauber aufgehängt und sofort griffbereit!

Einfache Montage mit nur 4 Schrauben

Trägermodul, Stahlblech

Farbe: Metallteile dunkelgrau

Produktmaße (B x T x H): 137 x 352 x 262 mm

Verpackungsmaße (B x T x H): 140 x 375 x 290 mm

Gewicht mit Verpackung: 1,8 kg

Für Schränke mit Drehtür.

For cabinets with hinged door.

Shelf (including sweeping set)

This universal shelf is ideal for storing buckets, other containers, and much more. An integrated hook under the shelf creates additional hanging options, for wipes and cloths, or the integrated sweeping set.

Easy installation with 4 screws only. Carrier shelf in sheet steel, included sweeping set.

Colour: Metal dark grey
 Product dimensions (W x D x H): 289 x 480 x 158 mm (without sweeping set) / H 305 mm (including sweeping set)
 Packing dimensions (W x D x H): 340 x 500 x 125 mm
 Weight incl. packing: 3,1 kg

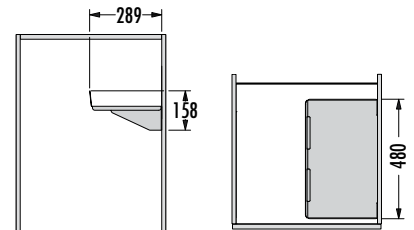

Broom / Wiper Holder makes room for the often bulky brooms, wipers, scrubbers, etc. Neatly hanged and at once ready to hand!

Easy installation with 4 screws only

Carrier bracket, sheet steel

Colour: Metal parts white
 Product dimensions (W x D x H): 137 x 352 x 262 mm
 Packing dimensions (W x D x H): 140 x 375 x 290 mm
 Weight incl. packing: 1,8 kg

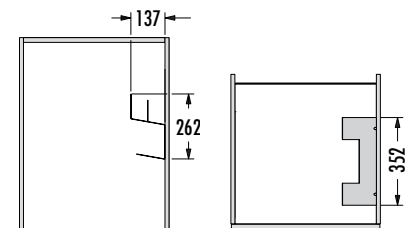

Broom / Wiper Holder makes room for the often bulky brooms, wipers, scrubbers, etc. Neatly hanged and at once ready to hand!

Easy installation with 4 screws only

Carrier bracket, sheet steel

Colour: Metal parts dark grey
 Product dimensions (W x D x H): 137 x 352 x 262 mm
 Packing dimensions (W x D x H): 140 x 375 x 290 mm
 Weight incl. packing: 1,8 kg

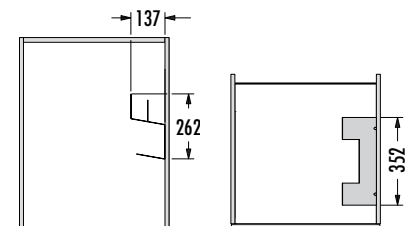

30 cm

40 cm

45 cm

50 cm

60 cm

80 cm

90 cm

Inch

SWING.



HAILO Multifunktionshalterung. HAILO Multifunctional Holder.

3272161



Praktische Halterung zur Aufnahme von senkrecht stehenden Gegenständen wie z.B. Bügeltisch und Leiter. Gegenstände werden platzsparend und kipp sicher verstaut.

Multifunktionshalterung aus Stahlblech

Farbe: **Metallteile weiß**
Produktmaße (B x T x H): 155 x 350 x 50 mm
Verpackungsmaße (B x T x H): 170 x 365 x 65 mm
Gewicht mit Verpackung: 1,4 kg
Verpackungseinheit: 2 Stück

Farbe: **3272181** **Metallteile dunkelgrau**

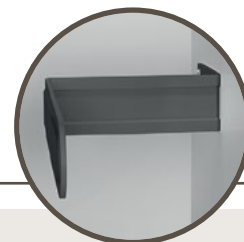
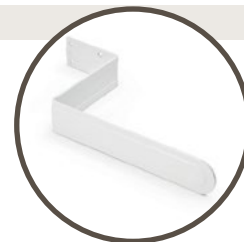

HAILO Wertstoff Depot dunkelgrau. HAILO Collector dark grey.

3272121



Das praktische Wertstoffdepot zum Einbau in Schränke oder außen an die Schrankwand. Trägermodul und große Deckelklappe aus stabilem, pulverbeschichtetem Stahlblech. Einhängenvorrichtung für Müllsäcke oder Stoffbeutel. Einfache Montage mit nur 4 Schrauben. Inklusive stabilem Baumwollsack

Farbe: **Metallteile dunkelgrau**
Produktmaße (B x T x H): 404 x 261 x 125 mm
Verpackungsmaße (B x T x H): 420 x 280 x 145 mm
Gewicht mit Verpackung: 2,3 kg

HAILO Wertstoff Depot weiß. HAILO Collector white.

3272111



Das praktische Wertstoffdepot zum Einbau in Schränke oder außen an die Schrankwand. Trägermodul und große Deckelklappe aus stabilem, pulverbeschichtetem Stahlblech. Einhängenvorrichtung für Müllsäcke oder Stoffbeutel. Einfache Montage mit nur 4 Schrauben. Inklusive stabilem Baumwollsack

Farbe: **Metallteile weiß**
Produktmaße (B x T x H): 404 x 261 x 125 mm
Verpackungsmaße (B x T x H): 420 x 280 x 145 mm
Gewicht mit Verpackung: 2,3 kg

Für Schränke mit Drehtür.

For cabinets with hinged door.

Practical holder for holding upright objects, e. g. ironing board and ladder. Objects are stowed space-saving and unable to tip over.

Multifunctional bracket, made of sheet steel

Colour: **Metal parts white**
 Product dimensions (W x D x H): 155 x 350 x 50 mm
 Packing dimensions (W x D x H): 170 x 365 x 65 mm
 Weight incl. packing: 1,4 kg
 Packing unit: 2 pieces

Colour: **Metal dark grey**

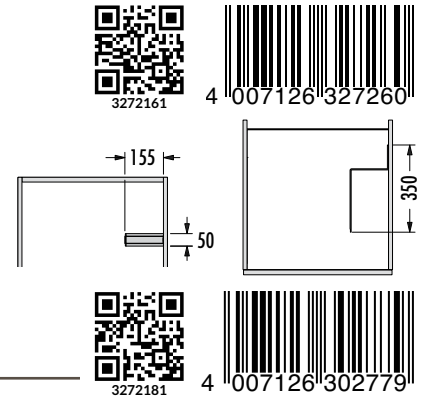

The handy metal frame with cotton-bag for fitting inside or outside the cupboard.
 Wall Bracket and large Lid made of sturdy powder-coated sheet-metal.
 With attachment device for plastic bin-liners or cotton fabric-bags.
 Easy installation with just 4 screws.

Comes with sturdy Cotton-Bag

Colour: **Metal parts dark grey**
 Product dimensions (W x D x H): 404 x 261 x 125 mm
 Packing dimensions (W x D x H): 420 x 280 x 145 mm
 Weight incl. packing: 2,3 kg

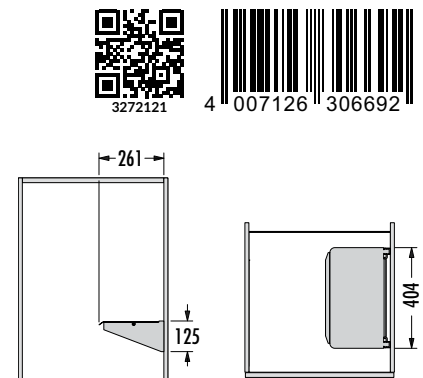

The handy metal frame with cotton-bag for fitting inside or outside the cupboard.
 Wall Bracket and large Lid made of sturdy powder-coated sheet-metal.
 With attachment device for plastic bin-liners or cotton fabric-bags.
 Easy installation with just 4 screws.

Comes with sturdy Cotton-Bag

Colour: **Metal parts white**
 Product dimensions (W x D x H): 404 x 261 x 125 mm
 Packing dimensions (W x D x H): 420 x 280 x 145 mm
 Weight incl. packing: 2,3 kg

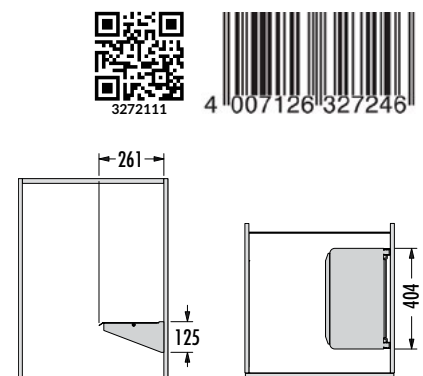

30 cm

40 cm

45 cm

50 cm

60 cm

80 cm

90 cm

Inch

60 CM SWING.

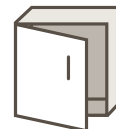

HAILO 2 Utensilienbehälter mit Wandhalter. *HAILO Two Accessories Boxes with wall-bracket.*

3271501



2 Utensilienbehälter mit Wandhalter (zum Einhängen und Herausnehmen)
für Klammern und Kleinteile

Farbe:	Kunststoffteile blau, Metallteile weiß
Einbau-Maße (B x T x H):	436 x 198 x 241 mm
Verpackungsmaße (B x T x H):	390 x 220 x 215 mm
Gewicht mit Verpackung:	1,1 kg

HAILO 2 Utensilienbehälter mit Wandhalter. *HAILO Two Accessories Boxes with wall-bracket.*

3271841



2 Utensilienbehälter mit Wandhalter (zum Einhängen und Herausnehmen)
für Klammern und Kleinteile

Farbe:	Kunststoffteile weiß, Metallteile dunkelgrau
Einbau-Maße (B x T x H):	436 x 198 x 241 mm
Verpackungsmaße (B x T x H):	390 x 220 x 215 mm
Gewicht mit Verpackung:	1,1 kg

HAILO Anbau Wäschetrockner. *HAILO Laundry-Rack.*

3271901



Anbau Wäschetrockner (zum Anbau außen am Schrank oder an der Wand – klappbar)

Farbe:	Metallteile weiß
Einbau-Maße (B x T x H):	525 x 820 x 300 mm
Verpackungsmaße (B x T x H):	740 x 545 x 200 mm
Gewicht mit Verpackung:	3,6 kg

Für 600 mm breite Schränke mit Drehtür.

For 600 mm wide cabinets with hinged door.

Two Accessories Boxes with wall-bracket hanger
space required for pegs and miscellaneous items

Colour: plastic parts blue, metal parts white
Built-In dimensions (W x D x H): 436 x 198 x 241 mm
Packing dimensions (W x D x H): 390 x 220 x 215 mm
Weight incl. packing: 1,1 kg



3271501

4 007126 327154

Two Accessories Boxes with wall-bracket hanger
space required for pegs and miscellaneous items

Colour: plastic parts white, metal parts dark grey
Built-In dimensions (W x D x H): 436 x 198 x 241 mm
Packing dimensions (W x D x H): 390 x 220 x 215 mm
Weight incl. packing: 1,1 kg



3271841

4 007126 302762

Laundry-Rack, externally wall-mounted, foldaway type,
modified metal-parts and metal-bars.

Colour: Metal parts white
Built-In dimensions (W x D x H): 525 x 820 x 300 mm
Packing dimensions (W x D x H): 740 x 545 x 200 mm
Weight incl. packing: 3,6 kg



3271901

4 007126 153012

30 cm

40 cm

45 cm

50 cm

60 cm

80 cm

90 cm

Inch

60 CM SWING.

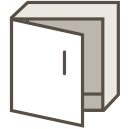

HAILO Getränkekistenhalter dunkelgrau. *HAILO Beverage crate holder dark grey.*

3273611



NEW

Cleveres Einbaumodul aus stabilem Stahlrohr. Einfache Montage. Getränkekisten in Standardgröße können eingestellt werden und deren Inhalt ist griffbereit zur Verfügung.

Farbe: Metallteile dunkelgrau
Montageart: **Seitenwandmontage**, Seitenwandstärke 16 mm
 Produktmaße (B x T x H): 568 x 325 x 25 mm
 Verpackungsmaße (B x T x H): 583 x 339 x 39 mm

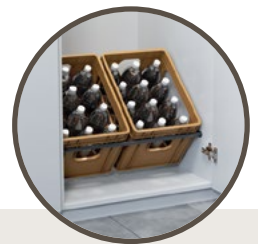

HAILO Universalablage dunkelgrau. *HAILO Universal tray dark grey.*

3273621



NEW

Stahlblech Ablageboden als Ergänzung zu Getränkekistenhalter. Einfach auflegen und schon bietet sich eine Ablagefläche für bspw. Getränke-SixPacks oder einzelne Flaschen.

Farbe: Metallteile dunkelgrau
Montageart: **Seitenwandmontage**, Seitenwandstärke 16 mm
 Produktmaße (B x T x H): 255 x 500 x 25 mm
 Verpackungsmaße (B x T x H): 514 x 269 x 39 mm

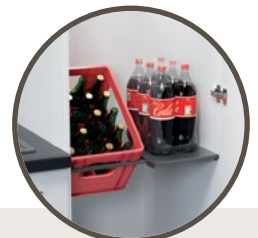

HAILO Flaschenhalter dunkelgrau. *HAILO Bottle holder dark grey.*

3273631



NEW

Praktisches Einbaumodul aus Stahlblech zur Lagerung von bspw. Weinflaschen. Die Flaschen werden „kopfüber“ in die Lochöffnungen gesteckt. Saubere, praktische Entnahme der Flaschen jederzeit möglich. Je Modul Aufnahmekapazität von 6 Flaschen. Bis zu drei Module (18 Flaschen) können hintereinander im Schrank auf einer Ebene untergebracht werden.

Farbe: Metallteile dunkelgrau
Montageart: **Seitenwandmontage**,
 Seitenwandstärke 16 mm
 Produktmaße (B x T x H): 568 x 84 x 80 mm
 Verpackungsmaße (B x T x H): 583 x 98 x 94 mm

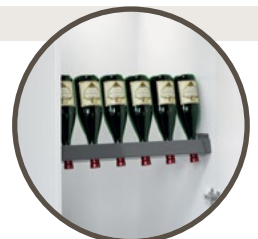

Für 600 mm breite Schränke mit Drehtür.

For 600 mm wide cabinets with hinged door.

Clever built-in module made of sturdy tubular steel.
Simple assembly. Standard-sized drinks crates can be stored and their contents are ready to hand.

Colour: Metal parts dark grey
Type of installation: inside available drawer, side-wall-thickness 16 mm
Built-In dimensions (W x D x H): 568 x 325 x 25 mm
Packing dimensions (W x D x H): 583 x 339 x 39 mm

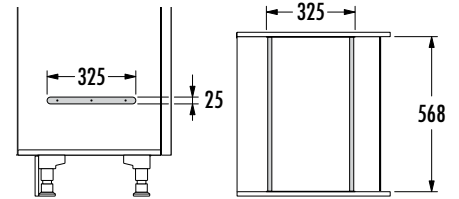

Sheet steel shelf as a supplement to drinks crate holders.
Simply place it on top to create a shelf for drinks six-packs or individual bottles, for example.

Colour: Metal parts dark grey
Type of installation: inside available drawer, side-wall-thickness 16 mm
Built-In dimensions (W x D x H): 255 x 500 x 25 mm
Packing dimensions (W x D x H): 514 x 269 x 39 mm

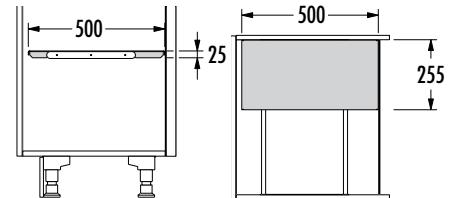

Practical built-in module made of sheet steel for storing wine bottles, for example.
The bottles are inserted "upside down" into the perforated openings.
Bottles can be removed cleanly and conveniently at any time.
Each module can hold 6 bottles. Up to three modules (18 bottles) can be stored one behind the other in the bar on one level.

Colour: Metal parts dark grey
Type of installation: inside available drawer, side-wall-thickness 16 mm
Built-In dimensions (W x D x H): 568 x 84 x 80 mm
Packing dimensions (W x D x H): 583 x 98 x 94 mm

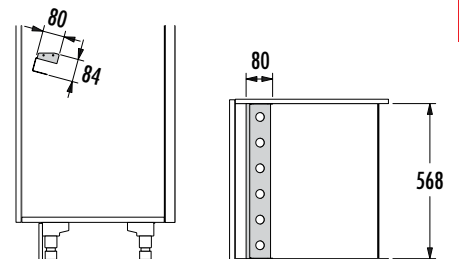

30 cm

40 cm

45 cm

50 cm

60 cm

80 cm

90 cm

Inch



Week

23.01.2020
Lisa Geburtstag
Cina + Opa Essen
Kocher reparieren
Schlafzug
...

RECEIVED





30 cm

40 cm

45 cm

50 cm

60 cm

80 cm

90 cm

Inch

HAILO Laundry Carrier.

Frisch- und Schmutzwäsche sauber verstaut in großen, tragbaren Systemkörben.

Dirty linen and wet, clean laundry stored in large, portable baskets.



Für Unterschränke.

For base cabinets.

45 / 50 CM SLIDE.



HAILO Laundry Carrier 450.



3270461

Wäschebehälter:	2 x 33 l
Montageart:	Seitenwandmontage, selbstjustierend 16 - 19 mm
Auszugsschienen:	abgedeckter, gedämpfter Selbsteinzug mit synchronisiertem Überauszug
Farbe:	Metallteile weiß, Kunststoffteile weiß / blau
Produktmaße (B x T x H):	412-418 x 528 x 545 mm
Systemtiefe:	528 mm
Verpackungsmaße (B x T x H):	490 x 320 x 620 mm
Gewicht mit Verpackung:	13 kg

HAILO Laundry Carrier 450 dunkelgrau.



3270811

Wäschebehälter:	2 x 33 l
Montageart:	Seitenwandmontage, selbstjustierend 16 - 19 mm
Auszugsschienen:	abgedeckter, gedämpfter Selbsteinzug mit synchronisiertem Überauszug
Farbe:	Metallteile dunkelgrau, Kunststoffteile weiß
Produktmaße (B x T x H):	412-418 x 528 x 545 mm
Systemtiefe:	528 mm
Verpackungsmaße (B x T x H):	490 x 320 x 620 mm
Gewicht mit Verpackung:	13 kg

HAILO Laundry Carrier 500.



3270551

Wäschebehälter:	2 x 33 l
Montageart:	Seitenwandmontage, selbstjustierend
Auszugsschienen:	abgedeckter, gedämpfter Selbsteinzug mit synchronisiertem Überauszug
Farbe:	Metallteile weiß, Kunststoffteile weiß / blau
Produktmaße (B x T x H):	462-468 x 528 x 545 mm
Systemtiefe:	528 mm
Verpackungsmaße (B x T x H):	490 x 320 x 620 mm
Gewicht mit Verpackung:	13,3 kg

Für 45 cm, 50 cm breite Unterschränke.

For 45 cm, 50 cm wide base-cabinets.

Baskets capacity: 2 x 33 l
Type of installation: Sidewall mounting, self-adjust. 16 to 19 mm
Slides: covered, dampened slides with self-closing device with fully synchronized over-travel
Colour: Metal parts white, Plastic parts white / blue
Product dimensions (W x D x H): 412-418 x 528 x 545 mm
System-depth: 528 mm
Packing dimensions (W x D x H): 490 x 320 x 620 mm
Weight incl. packing: 13 kg

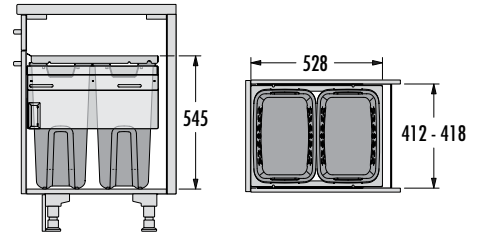

Baskets capacity: 2 x 33 l
Type of installation: Sidewall mounting, self-adjust. 16 to 19 mm
Slides: covered, dampened slides with self-closing device with fully synchronized over-travel
Colour: Metal parts dark grey, Plastic parts white
Product dimensions (W x D x H): 412-418 x 528 x 545 mm
System-depth: 528 mm
Packing dimensions (W x D x H): 490 x 320 x 620 mm
Weight incl. packing: 13 kg

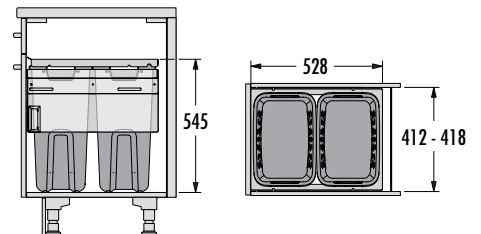

Baskets capacity: 2 x 33 l
Type of installation: Sidewall mounting, self-adjust
Slides: covered, dampened slides with self-closing device with fully synchronized over-travel
Colour: Metal parts white, Plastic parts white / blue
Product dimensions (W x D x H): 462-468 x 528 x 545 mm
System-depth: 528 mm
Packing dimensions (W x D x H): 490 x 320 x 620 mm
Weight incl. packing: 13,3 kg

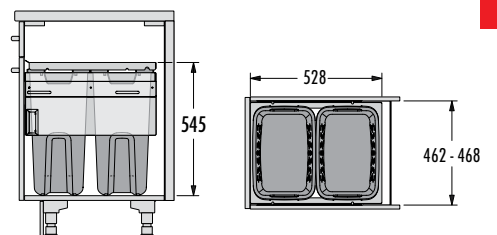

30 cm

40 cm

45 cm

50 cm

60 cm

80 cm

90 cm

Inch

50 / 60 CM SLIDE.

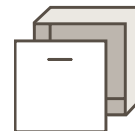

HAILO Laundry Carrier 500 dunkelgrau.



3270851

Wäschebehälter:	2 x 33 l
Montageart:	Seitenwandmontage, selbstjustierend
Auszugsschienen:	abgedeckter, gedämpfter Selbsteinzug mit synchronisiertem Überauszug
Farbe:	Metallteile dunkelgrau, Kunststoffteile weiß
Produktmaße (B x T x H):	462-468 x 528 x 545 mm
Systemtiefe:	528 mm
Verpackungsmaße (B x T x H):	490 x 320 x 620 mm
Gewicht mit Verpackung:	13,3 kg

HAILO Laundry Carrier 600.



3270611

Wäschebehälter:	2 x 33 l, Zusatzbehälter 1 x 12 l, 1 x 2,5 l
Montageart:	Seitenwandmontage, selbstjustierend 16 - 19 mm
Auszugsschienen:	abgedeckter, gedämpfter Selbsteinzug mit synchronisiertem Überauszug
Farbe:	Metallteile weiß, Kunststoffteile weiß / blau
Produktmaße (B x T x H):	562-568 x 528 x 545 mm
Systemtiefe:	528 mm
Verpackungsmaße (B x T x H):	590 x 325 x 620 mm
Gewicht mit Verpackung:	15,5 kg

HAILO Laundry Carrier 600 dunkelgrau.



3270831

Wäschebehälter:	2 x 33 l, Zusatzbehälter 1 x 12 l, 1 x 2,5 l
Montageart:	Seitenwandmontage, selbstjustierend 16 - 19 mm
Auszugsschienen:	abgedeckter, gedämpfter Selbsteinzug mit synchronisiertem Überauszug
Farbe:	Metallteile dunkelgrau, Kunststoffteile weiß
Produktmaße (B x T x H):	562-568 x 528 x 545 mm
Systemtiefe:	528 mm
Verpackungsmaße (B x T x H):	590 x 325 x 620 mm
Gewicht mit Verpackung:	15,5 kg

Für 50 cm, 60 cm breite Unterschränke.

For 50 cm, 60 cm wide base-cabinets.

Baskets capacity: 2 x 33 l
Type of installation: Sidewall mounting, self-adjust
Slides: covered, dampened slides with self-closing device with fully synchronized over-travel
Colour: Metal parts dark grey, Plastic parts white
Product dimensions (W x D x H): 462-468 x 528 x 545 mm
System-depth: 528 mm
Packing dimensions (W x D x H): 490 x 320 x 620 mm
Weight incl. packing: 13,3 kg

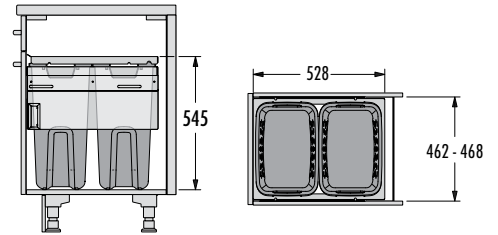

Baskets capacity: 2 x 33 l
 add. Bins 1 x 12 l, 1 x 2,5 l
Type of installation: Sidewall mounting, self-adjust. 16 to 19 mm
Slides: covered, dampened slides with self-closing device with fully synchronized over-travel
Colour: Metal parts white, Plastic parts white / blue
Product dimensions (W x D x H): 562-568 x 528 x 545 mm
System-depth: 528 mm
Packing dimensions (W x D x H): 590 x 325 x 620 mm
Weight incl. packing: 15,5 kg

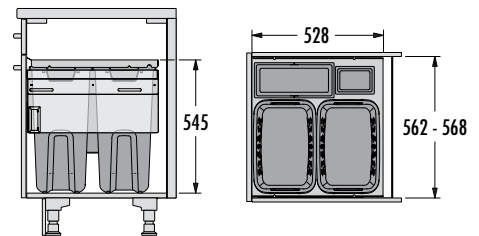

Baskets capacity: 2 x 33 l
 add. Bins 1 x 12 l, 1 x 2,5 l
Type of installation: Sidewall mounting, self-adjust. 16 to 19 mm
Slides: covered, dampened slides with self-closing device with fully synchronized over-travel
Colour: Metal parts dark grey, Plastic parts white
Product dimensions (W x D x H): 562-568 x 528 x 545 mm
System-depth: 528 mm
Packing dimensions (W x D x H): 590 x 325 x 620 mm
Weight incl. packing : 15,5 kg

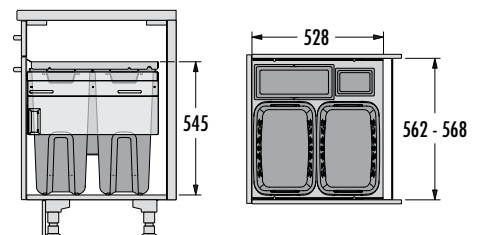

30 cm

40 cm

45 cm

50 cm

60 cm

80 cm

90 cm

Inch

60 CM SLIDE.

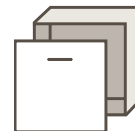

HAILO Laundry Carrier S 600.

3270691



Wäschebehälter:	2 x 33 l
Montageart:	Seitenwandmontage, selbstjustierend 16 - 19 mm
Auszugsschiene:	abgedeckter, gedämpfter Selbsteinzug mit Überauszug
Farbe:	Metallteile weiß, Kunststoffteile weiß / blau
Produktmaße (B x T x H):	562 - 568 x 448 x 545
Systemtiefe:	448 mm
Verpackungsmaße (B x T x H):	590 x 325 x 620 mm
Gewicht mit Verpackung:	12,5 kg

HAILO Laundry Carrier S 600 dunkelgrau.

3270841



Wäschebehälter:	2 x 33 l
Montageart:	Seitenwandmontage, selbstjustierend 16 - 19 mm
Auszugsschiene:	abgedeckter, gedämpfter Selbsteinzug mit Überauszug
Farbe:	Metallteile dunkelgrau, Kunststoffteile weiß
Produktmaße (B x T x H):	562 - 568 x 448 x 545
Systemtiefe:	448 mm
Verpackungsmaße (B x T x H):	590 x 325 x 620 mm
Gewicht mit Verpackung:	12,5 kg

Für 60 cm breite Unterschränke.

For 60 cm wide base-cabinets.

Baskets capacity: 2 x 33 l
Type of installation: Sidewall mounting, self-adjust. 16 to 19 mm
Slides: covered, dampened slides with self-closing device with over-travel
Colour: Metal parts white, Plastic parts white / blue
Product dimensions (W x D x H): 562 - 568 x 448 x 545
System-depth: 448 mm
Packing dimensions (W x D x H): 590 x 325 x 620 mm
Weight incl. packing: 12,5 kg



3270691



4 007126 327079

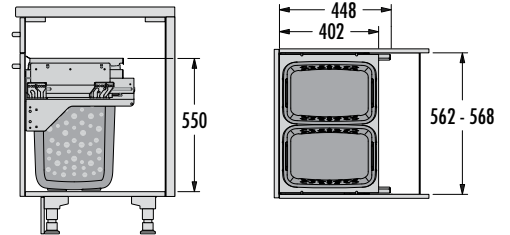

Baskets capacity: 2 x 33 l
Type of installation: Sidewall mounting, self-adjust. 16 to 19 mm
Slides: covered, dampened slides with self-closing device with over-travel
Colour: Metal parts dark grey, Plastic parts white
Product dimensions (W x D x H): 562 - 568 x 448 x 545
System-depth: 448 mm
Packing dimensions (W x D x H): 590 x 325 x 620 mm
Weight incl. packing: 12,5 kg



3270841



4 007126 302724

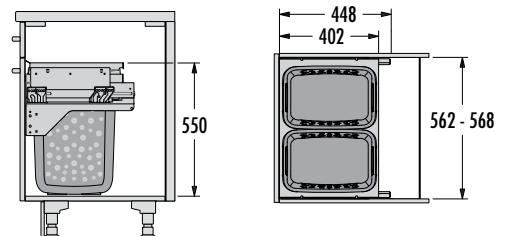

30 cm

40 cm

45 cm

50 cm

60 cm

80 cm

90 cm

Inch

45 / 60 CM SLIDE.

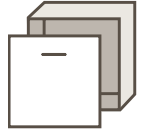

HAILO Laundry Carrier 450 Bad. *HAILO Laundry Carrier 450 Bathroom.*

3270471



Behälter:	1 x 33 l
Montageart:	Seitenwandmontage, selbstjustierend 16 - 19 mm
Auszugsschiene:	abgedeckter Selbsteinzug
Farbe:	Metallteile silber, Kunststoffteile weiß
Produktmaße (B x T x H):	412-418 x 298 x 531
Systemtiefe:	298 mm
Verpackungsmaße (B x T x H):	510 x 345 x 560 mm
Gewicht mit Verpackung:	7 kg

HAILO Laundry Carrier 600 Bad. *HAILO Laundry Carrier 600 Bathroom*

3270621



Wäschebehälter:	1 x 33 l, Zusatzbehälter 1 x 4 l
Montageart:	Seitenwandmontage, selbstjustierend 16 - 19 mm
Auszugsschienen:	abgedeckter Selbsteinzug
Farbe:	Metallteile silber, Kunststoffteile weiß
Produktmaße (B x T x H):	562-568 x 298 x 531 mm
Systemtiefe:	298 mm
Verpackungsmaße (B x T x H):	510 x 345 x 560 mm
Gewicht mit Verpackung:	7,7 kg

Für 45 cm oder 60 cm breite Unterschränke.

For 45 cm or 60 cm wide base-cabinets.

Baskets capacity: 1 x 33 l
Type of installation: Sidewall mounting, self-adjust. 16 to 19 mm
Slides: covered slides with over-travel
Colour: Metal parts silver, Plastic parts white
Product dimensions (W x D x H): 412-418 x 298 x 531 mm
System-depth: 298 mm
Packing dimensions (W x D x H): 510 x 345 x 560 mm
Weight incl. packing: 7 kg

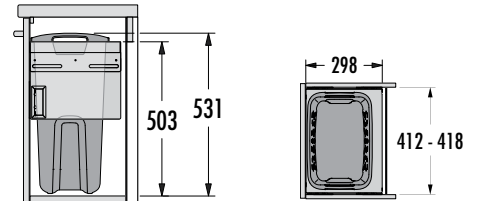

Baskets capacity: 1 x 33 l, add. Bins 1 x 4 l
Type of installation: Sidewall mounting, self-adjust. 16 to 19 mm
Slides: covered slides with over-travel
Colour: Metal parts silver, Plastic parts white
Product dimensions (W x D x H): 562-568 x 298 x 531 mm
System-depth: 298 mm
Packing dimensions (W x D x H): 510 x 345 x 560 mm
Weight incl. packing: 7,7 kg

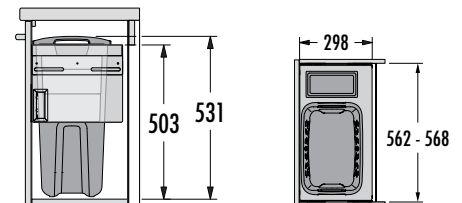

30 cm

40 cm

45 cm

50 cm

60 cm

80 cm

90 cm

Inch



Inneneimer & Zubehör.

Inner bins & accessories.

30 cm

40 cm

45 cm

50 cm

60 cm

80 cm

90 cm

Inch



252 - 267
Inneneimer.
Inner bins.



270 - 271
On-Top-Behälter.
On top container.



270 - 271
Schlauchbrausenabweiser.
Wall-bracket for flex-hose.



270 - 271
Kitty.





30 cm

40 cm

45 cm

50 cm

60 cm

80 cm

90 cm

Inch

HAILO Inneneimer.

HAILO Inner bins.

Saubere Vielfalt.

Clean diversity.

HAILO Inneneimer. *HAILO Inner Bins.*



Art. Nr. Deckel/ <i>lid</i>			1107279	1136319	
Art. Nr. Eimer/ <i>bin</i>	1102429	1129889	1107289	1138979	1136309
Volumen ca./ <i>Volume aprox.</i>	2,5 Liter	2,5 Liter	6,5 Liter	6,5 Liter	14 Liter
Breite x Tiefe / <i>Width x Depth</i>	B x T / <i>W x D</i>	B x T / <i>W x D</i>	B x T / <i>W x D</i>	B x T / <i>W x D</i>	B x T / <i>W x D</i>
Eimerhöhe/ <i>bin height</i> 220 mm	155 x 110	155x 110	226 x 174	226 x 174	350 x 226
Eimerhöhe/ <i>bin height</i> 255 mm					
Eimerhöhe/ <i>bin height</i> 295 mm					



Art. Nr. Deckel/ <i>lid</i>	1225969	1107249			1104849
Art. Nr. Eimer/ <i>bin</i>	1225959	1102449	1138989	1225949	1093479
Volumen ca./ <i>Volume aprox.</i>	8 Liter	12 Liter	12 Liter	12 Liter	18 Liter
Breite x Tiefe / <i>Width x Depth</i>	B x T / <i>W x D</i>	B x T / <i>W x D</i>	B x T / <i>W x D</i>	B x T / <i>W x D</i>	B x T / <i>W x D</i>
Eimerhöhe/ <i>bin height</i> 295 mm	226 x 156	320 x 156	320 x 156	320 x 156	320 x 226
Eimerhöhe/ <i>bin height</i> 350 mm					



1100719	1068589	1104849	1068589	1129979	
1073979	1102439	1102459	1075959	1129909	1222479
14 Liter	7 Liter	15 Liter	8 Liter	8 Liter	8 Liter
<i>B x T / W x D</i>	<i>B x T / W x D</i>	<i>B x T / W x D</i>	<i>B x T / W x D</i>	<i>B x T / W x D</i>	<i>B x T / W x D</i>
350 x 226					
	226 x 156	320 x 226			
			226 x 156	226 x 156	226 x 156



1129959	1222489	1225939	1068589		1125089	1134679
1075969			1075969	1224679	1122459	1134669
18 Liter	18 Liter	18 Liter	10 Liter	8 Liter	12 Liter	12 Liter
<i>B x T / W x D</i>	<i>B x T / W x D</i>	<i>B x T / W x D</i>	<i>B x T / W x D</i>	<i>B x T / W x D</i>	<i>B x T / W x D</i>	<i>B x T / W x D</i>
320 x 226	320 x 226	320 x 226				
			226 x 156	242 x 138	320 x 141	320 x 141

30 cm

40 cm

45 cm

50 cm

60 cm

80 cm

90 cm

Inch

HAILO Inneneimer. *HAILO Inner Bins.*



Art. Nr. Deckel/ <i>lid</i>	1220069	1107249	1107269		
Art. Nr. Eimer/ <i>bin</i>	1138999	1075989	1076099	1222509	1225979
Volumen ca./ <i>Volume aprox.</i>	13 Liter	14 Liter	15 Liter	15 Liter	15 Liter
Breite x Tiefe / <i>Width x Depth</i>	B x T / <i>W x D</i>	B x T / <i>W x D</i>	B x T / <i>W x D</i>	B x T / <i>W x D</i>	B x T / <i>W x D</i>
Eimerhöhe/ <i>bin height</i> 350 mm	207 x 242	320 x 156	226 x 233	226 x 233	226 x 233



Art. Nr. Deckel/ <i>lid</i>	1220389	x	x	
Art. Nr. Eimer/ <i>bin</i>	1220359	1220369	1220379	
Volumen ca./ <i>Volume aprox.</i>	13 Liter	18 Liter	28 Liter	
Breite x Tiefe / <i>Width x Depth</i>	B x T / <i>W x D</i>	B x T / <i>W x D</i>	B x T / <i>W x D</i>	
Eimerhöhe/ <i>bin height</i> 380 mm	242 x 192	385 x 166	385 x 242	

Eimerhöhe/ *bin height* 413 mm



x	1104849	x	1100719	x	x
1139009	1076119	1129669	1076129	1125729	1129969
17 Liter	20 Liter	21 Liter	24 Liter	28 Liter	28 Liter
B x T / W x D	B x T / W x D	B x T / W x D	B x T / W x D	B x T / W x D	B x T / W x D
415 x 158	320 x 226	415 x 192	350 x 226	242 x 415	242 x 415



1107239	x	x	x	
1107229	1071319	1058089	1137679	
13 Liter	19 Liter	30 Liter	30 Liter	
B x T / W x D	B x T / W x D	B x T / W x D	B x T / W x D	
258 x 198	397 x 171	397 x 258	397 x 258	

30 cm
40 cm
45 cm
50 cm
60 cm
80 cm
90 cm
Inch

HAILO Inneneimer. *HAILO Inner Bins.*

























Art. Nr. Deckel/ <i>lid</i>	1100719	x	x	1223649	
Art. Nr. Eimer/ <i>bin</i>	1100709	1080369	1139029	1222549	
Volumen ca./ <i>Volume aprox.</i>	29 Liter	42 Liter	55 Liter	15 Liter	
Breite x Tiefe / <i>Width x Depth</i>	B x T / <i>W x D</i>	B x T / <i>W x D</i>	B x T / <i>W x D</i>	B x T / <i>W x D</i>	
Eimerhöhe/ <i>bin height</i> 485 mm	350 x 226				
Eimerhöhe/ <i>bin height</i> 500 mm		415 x 285	385 x 358	269 x 176	
Eimerhöhe/ <i>bin height</i> 522 mm					
Eimerhöhe/ <i>bin height</i> 525 mm					



	x	x	1128339	x	1100719
	1222559	1222569	1014169	1132999	1130439
	37 Liter	42 Liter	38 Liter	38 Liter	35 Liter
	<i>B x T / W x D</i>	<i>B x T / W x D</i>	<i>B x T / W x D</i>	<i>B x T / W x D</i>	<i>B x T / W x D</i>
	370 x 269	414 x 269			
			378 x 261	378 x 261	
					350 x 226

30 cm
40 cm
45 cm
50 cm
60 cm
80 cm
90 cm
Inch

HAILO Inneneimer. *HAILO Inner Bins.*

Breite / Width	155 mm	207 mm	226 mm	226 mm	233 mm	242 mm	242 mm	258 mm	269 mm	320 mm	320 mm	320 mm	350 mm
Tiefe / Depth	110 mm	242 mm	156 mm	174 mm	226 mm	138 mm	192 mm	198 mm	176 mm	141 mm	156 mm	226 mm	226 mm
Art. Nr.	Art. Nr.	Art. Nr.	Art. Nr.	Art. Nr.	Art. Nr.	Art. Nr.	Art. Nr.	Art. Nr.	Art. Nr.	Art. Nr.	Art. Nr.	Art. Nr.	Art. Nr.
Eimerhöhe bin height													
220 mm	 1129889 2,5l 1102429			 1107279 6,5l 1107289 1136319 1138979									 1100719 14l 1073979 1136309
255 mm			 1068589 7l 1102439									 1104849 15l 1102459	
295 mm			 1068589 8l 1075959 1225969 1225959	 1129979 8l 1129909 1222479						 1107249 12l 1102449 1138989 1225949	 1104849 18l 1093479 1222469	 1100719 18l 1222469 1129959	
350 mm	 1220069 13l 1138999	 1068589 10l 1075969		 1107269 15l 1076099 1225979 1222509	 1224679 8l					 1125089 12l 1122459 1134679 1134669	 1107249 14l 1075989	 1104849 20l 1076119	 1100719 24l 1076129
380 mm								 1220389 13l 1220359					
413 mm								 1107239 13l 1107229					
485 mm													 1100719 29l 1100709
500 mm									 1223649 15l 1222549				
522 mm													
525 mm													 1100719 35l 1130439

* ohne Bügel / without handles ** ohne Bügel, mit integrierten geformten Griffen / without handles, with integrated moulded grip

HAILO Inneneimer. *HAILO Inner Bins.*



Art. Nr. Deckel/ <i>lid</i>	1017519	1017519	1082739	1082739	1082739
Art. Nr. Eimer/ <i>bin</i>	1086239	1094079	1094089	1045639	1221189
Volumen ca./ <i>Volume aprox.</i>	18 Liter	18 Liter	8,5 Liter	10 Liter	10 Liter
Breite x Tiefe / <i>Width x Depth</i>	B x T / <i>W x D</i>	B x T / <i>W x D</i>	B x T / <i>W x D</i>	B x T / <i>W x D</i>	B x T / <i>W x D</i>
Eimerhöhe/ <i>bin height</i> 295 mm	316 x 226	316 x 226	226 x 150		
Eimerhöhe/ <i>bin height</i> 350 mm				226 x 154	226 x 154



Art. Nr. Deckel/ <i>lid</i>				
Art. Nr. Eimer/ <i>bin</i>	1077859	1220969	1050209	1008879
Volumen ca./ <i>Volume aprox.</i>	20 Liter	20 Liter	24 Liter	15 Liter
Breite x Tiefe / <i>Width x Depth</i>	B x T / <i>W x D</i>	B x T / <i>W x D</i>	B x T / <i>W x D</i>	B x T / <i>W x D</i>
Eimerhöhe/ <i>bin height</i> 350 mm	316 x 226	316 x 226	345 x 220	230 x 220



1082739					
1045629	1082479	1082419	1068909	1220179	
10 Liter	7 Liter	7 Liter	7 Liter	7 Liter	
<i>B x T / W x D</i>	<i>B x T / W x D</i>	<i>B x T / W x D</i>	<i>B x T / W x D</i>	<i>B x T / W x D</i>	
226 x 154	226 x 115	226 x 115	226 x 115	226 x 115	



1045119	1073259	1073269	1221209	1220189	
15 Liter	15 Liter	15 Liter	15 Liter	15 Liter	
<i>B x T / W x D</i>	<i>B x T / W x D</i>	<i>B x T / W x D</i>	<i>B x T / W x D</i>	<i>B x T / W x D</i>	
230 x 220	230 x 220	230 x 220	230 x 220	230 x 220	

30 cm
40 cm
45 cm
50 cm
60 cm
80 cm
90 cm
Inch

HAILO Inneneimer. *HAILO Inner Bins.*



Art. Nr. Eimer/bin	1082119	1082399	1082409	1081529	
Volumen ca./ <i>Volume aprox.</i>	18 Liter	8 Liter	8 Liter	12 Liter	
Breite x Tiefe / <i>Width x Depth</i>	B x T / <i>W x D</i>	B x T / <i>W x D</i>	B x T / <i>W x D</i>	∅	
				270	
Eimerhöhe/ <i>bin height</i> 367 mm	343 x 185	187 x 171	187 x 171		
Eimerhöhe/ <i>bin height</i> 253 mm				253	
Eimerhöhe/ <i>bin height</i> 299 mm					
Eimerhöhe/ <i>bin height</i> 325 mm					
Eimerhöhe/ <i>bin height</i> 413 mm					
Eimerhöhe/ <i>bin height</i> 413 mm					



30 cm

40 cm

45 cm

50 cm

60 cm

80 cm

90 cm

Inch

1138739

1225049

1082629

1030459

15 Liter

20 Liter

15 Liter

20 Liter

0

0

0

0

270

270

275

275







325











299

413

417

HAILO Inneneimer. *HAILO Inner Bins.*

Breite/Width	187 mm	226 mm	226 mm	226 mm	230 mm
Tiefe/Depth	171 mm	115 mm	150 mm	154 mm	220 mm
	Art. Nr.	Art. Nr.	Art. Nr.	Art. Nr.	Art. Nr.
Eimerhöhe / bin height					
253 mm					
295 mm			 <p>1082739</p> <p>8,5l</p> <p>1094089 hellgrau/light-grey</p>		
299 mm					
325 mm					
350 mm		 <p>7l</p> <p>1082479 grau/grey</p> <p>1082419 weiß/white</p> <p>1068909 hellgrau/light grey</p> <p>1220179 dunkelgrau/dark-grey</p>	 <p>1082739</p> <p>10l</p> <p>1045639 grau/grey</p> <p>1045629 weiß/white</p> <p>1221189 dunkelgrau/dark-grey</p>	 <p>15l</p> <p>1221209 blau/blue</p> <p>1220189 dunkelgrau/dark-grey</p> <p>1073259 grün/green</p> <p>1073269 braun/brown</p> <p>1045119 weiß/white</p> <p>1008879 grau/grey</p>	
367 mm	 <p>8l</p> <p>1082399</p>  <p>1082409</p>				
413 mm					
417 mm					

316 mm	342 mm	345 mm	∅	∅	30 cm
226 mm	181 mm	220 mm	270 mm	275 mm	40 cm
Art. Nr.	Art. Nr.	Art. Nr.	Art. Nr.	Art. Nr.	45 cm
				 121 1081529	50 cm
 181 1094079 hellgrau/light-grey 1086239 schwarz/black					60 cm
					80 cm
				 151 1082629	90 cm
				 151 1138739	Inch
	 201 1077859  201 1220969	 241 1050209 grau/grey			
			 181 1082119		
					 201 1030459
				 201 1225049	





30 cm

40 cm

45 cm

50 cm

60 cm

80 cm

90 cm

Inch

HAILO Zubehör.

HAILO Accessories.

Für eine optimierte Raumnutzung.

For optimised use of space.

HAILO On Top Behälter. *HAILO On Top Container.*

3205101



Behälter: 1 x 4 l, 1 x Behälterdeckel 4 l
Farbe: Kunststoffteile hellgrün/weiß
Produktmaße (B x T x H): 230 x 180 x 107 mm
Verpackungsmaße (B x T x H): 247 x 190 x 121 mm
Gewicht mit Verpackung: 0,7 kg



HAILO Schlauchbrausenabweiser. *HAILO Wall-Bracket for Flex-Hose.*

3693001



Metallbügel zum Einbau in Spülenunterschranke zur gezielten Schlauchführung.

Farbe: Metallteile weiß
Verpackungsmaße (B x T x H): 445 x 190 x 85 mm
Verpackungseinheit: 5
Gewicht mit Verpackung: 0,2 kg



HAILO Kitty.

3204101



Behälter: Inhalt: 4 l, 1 x Behälterdeckel
Farbe: Kunststoffteile dunkelgrau, Deckel+Griff hellgrau
Produktmaße (B x T x H): 250 x 160 x 170 mm
Verpackungsmaße (B x T x H): 265 x 175 x 180 mm
Gewicht mit Verpackung: 0,86 kg



Zubehör.

Accessories.

Container: 1 x 4 l, 1 x Lid 4 l
Colour: Plastic parts light green/white
Product dimensions (W x D x H): 230 x 180 x 107 mm
Packing dimensions (W x D x H): 247 x 190 x 121 mm
Weight incl. packing: 0,7 kg



3205101



4 007126 320506

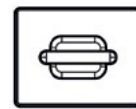
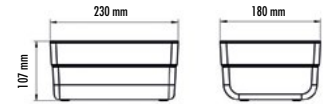

**Wire bracket for sink-cabinets,
for rerouting of flexible hoses.**

Colour: Metal parts white
Packing dimensions (W x D x H): 445 x 190 x 85 mm
Packing unit: 5 each per carton
Weight incl. packing: 0,2 kg



3693001



4 007126 369413

Container: 1 x 4 l, 1 x Lid 4 l
Colour: Plastic Body dark-grey, Lid+Handle light-grey
Product dimensions (W x D x H): 250 x 160 x 170 mm
Packing dimensions (W x D x H): 265 x 175 x 180 mm
Weight incl. packing: 0,86 kg



3204101



4 007126 320421

30 cm

40 cm

45 cm

50 cm

60 cm

80 cm

90 cm

Inch

Mehr von HAILO Einbautechnik.

More from HAILO Built-In Technology.

Kundenspezifische Lösungen. Customized Solutions.

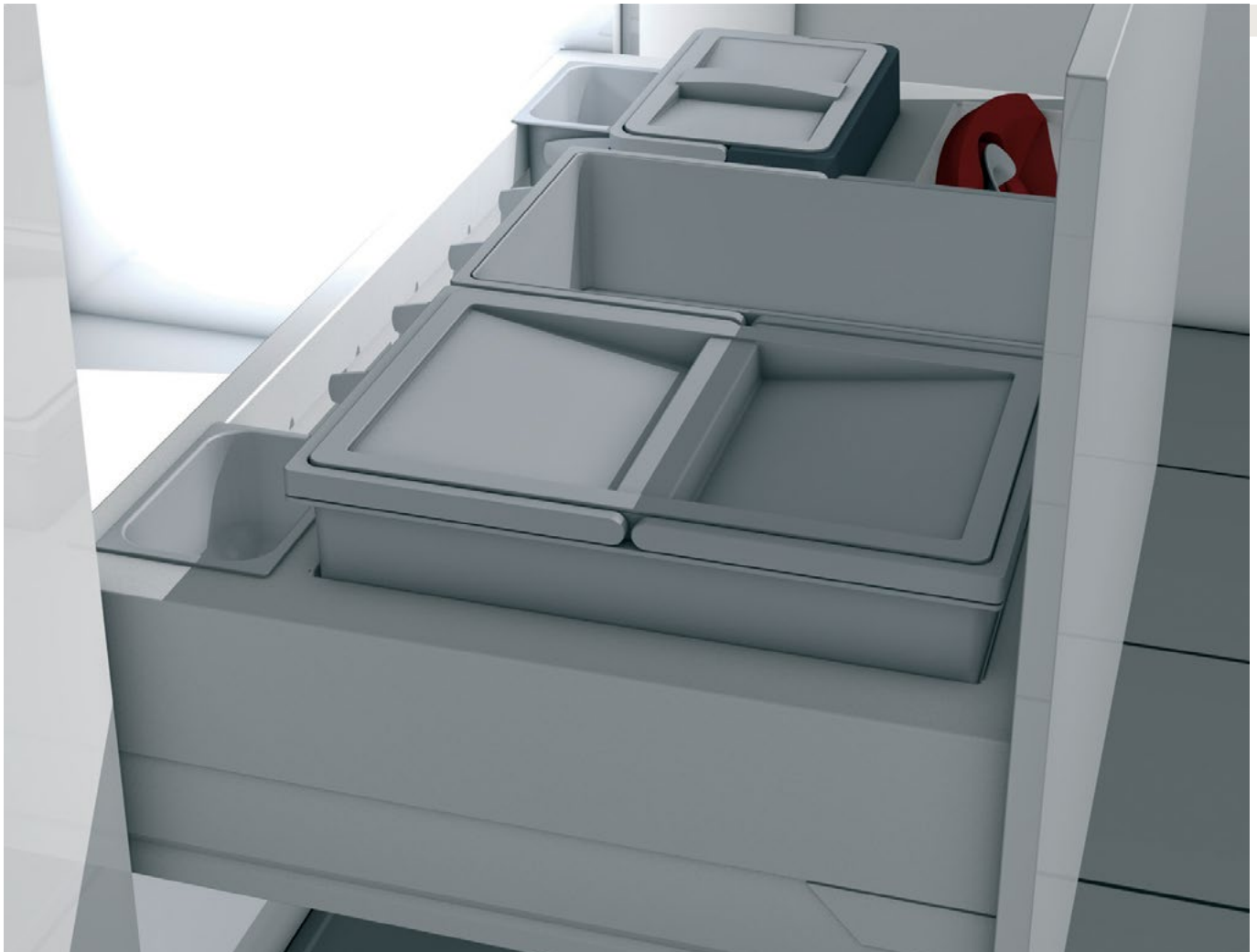

Neben dem umfangreichen Sortiment an Abfalltrenn- und Ordnungssystemen aus dem Standard Programm, bietet HAILO maßgeschneiderte, kundenspezifische Lösungen, die ihre Küchenmarke darin unterstützen einmalige Attribute aufzuweisen.

Passgenaue Entwicklungen auf alle vorhandenen Auszüge und Schubkastensysteme namhafter Hersteller wie Blum, Grass, Hettich und weitere bieten Individualität und ein hohes Maß an Differenzierung.

Diesen Mehrwert in der Raumausnutzung und Gestaltung der Auszüge und Schubkästen entwickelt HAILO gemeinsam mit Ihnen und für Sie.

Als Marktführer im Bereich Einbauten in Küchenschränke und Schubkästen finden wir auch für Sie passende Möglichkeiten.

Viele namhafte Küchenhersteller vermarkten bereits erfolgreich ihre Küchen mit maßgefertigten Einbausystemen von HAILO.

As well as the extensive choice of waste separation and storage systems in its standard range, HAILO offers made-to-measure, customised solutions that support kitchen brands with their unique features.

Precision-fit developments for all existing drawer systems and storage units supplied by well-known manufacturers, such as Blum, Grass, Hettich and others, lend individuality and provide for a high degree of differentiation.

HAILO develops this added value in the utilisation of space and the design of the drawer systems and storage units with you and for you. As the market leader in the kitchen cupboard and drawer storage fittings sector, we'll find the right options for you, too.

Many well-known kitchen manufacturers already successfully market their kitchens with customized recycling systems.

Kundenspezifische Lösungen für Zargen (hängende Systeme).

Customized solutions for Drawers (hang-thru bin systems).

HAILO Zargen Cargo. HAILO Drawer Cargo.

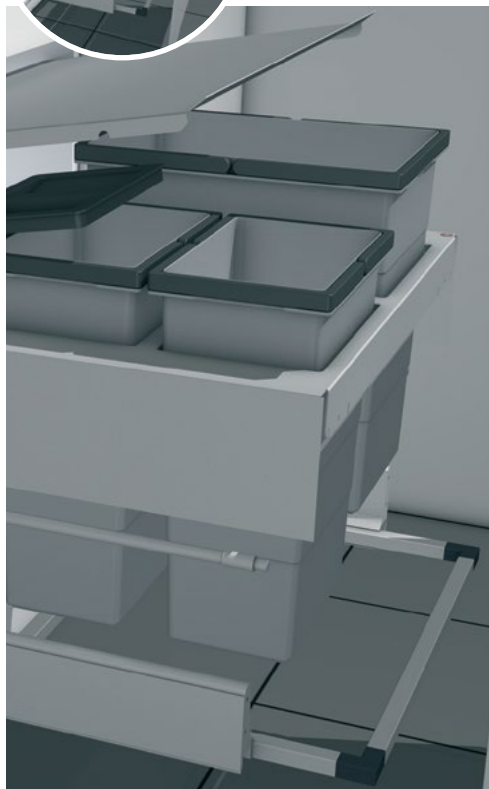
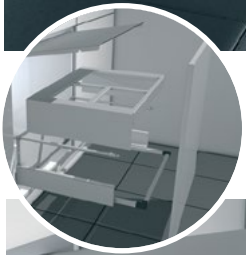

Passend auf alle handelsüblichen Zargen entwickelt HAILO ein patentiertes Abfalltrennsystem, das gleich mehrere Vorteile aufweist:

Einfache Montage
Unveränderte Frontanbindung
Stabilität
Hygiene
Individualität
Vielseitigkeit

Konfigurieren Sie sich die Einsätze für ihr System selbst. Wählen Sie ihre individuelle Systembestückung aus einer Vielzahl von Eimern und Einsätzen (siehe Seiten 254-267).

Beispiel einer Kundenlösung auf 60er Zarge

Suitable for all standard drawer frames, HAILO can develop a patented waste separation system for you that provides several benefits:

Easy Installation
Front-Attachment and -Adjustment as usual
Stability
Hygiene
Individuality
Variability

Configuration of Bins and Inserts as per your requirement, and available space. (Pages 254-267)

Example of a customized solution on a 60-drawer frame

Tragendes System.

Behälter hängen frei in der Eimeraufnahme. Schubkastenboden nicht nötig.

Individuelle Eimerbestückung.

Große Vielfalt an Varianten und Eimerkombinationen wählbar.

Geschlossenes System.

Glatte, reinigungsfreundliche Flächen. Fehleinwurf wird vermieden.

Stabilisierungsrahmen

als Ersatz für den Schubkastenboden. Zarge sitzt höher als bei normalem Auszug - dadurch erhöhte Stabilität.

Einstellbarkeit des Auszugs

Herkömmliche Einstellbarkeit der Front bleibt erhalten. Es werden keine weiteren Befestigungswinkel benötigt.

Passende Systeme für alle Zargen.

Egal welcher Hersteller, egal welche Breite oder Tiefe.

Einfache Montage,

bewährte Frontanbindung.

Upper Bins Frame, hang - thru bins, without drawer bottom.

Individual bin configuration, as per cabinet-maker's requirements.

Closed system, flush sides & surfaces.

Stabilizer frame, Alu, replaces drawer-bottom.

Adjustment of front-panel and attachment in the usual way. Not any extra brackets needed.

Suitable systems for all common drawers, of any make, of any width, or depth.

Easy installation, usual front-adjustment.

30 cm

40 cm

45 cm

50 cm

60 cm

80 cm

90 cm

Inch

Kundenspezifische Lösungen für Schubkästen (stehende Systeme).

Customized solutions for common drawers (standing bin systems).

HAILO Separato.

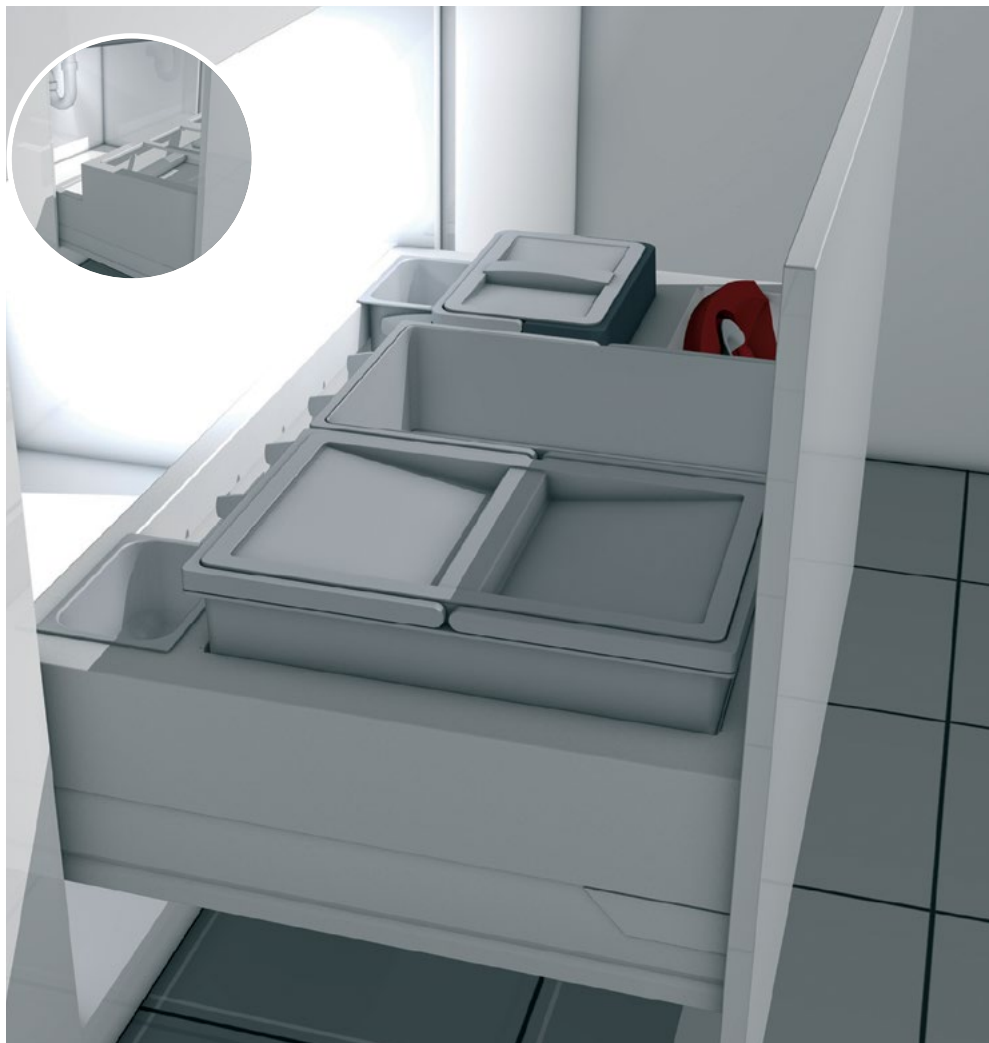

Für alle Schubladen und Schubkästen ab 2-Raster Höhe bietet HAILO mit dem Separato-System individuelle Gestaltungsmöglichkeiten.

Neu entwickeltes HAILO-System, patentiert, das gleich mehrere Vorteile aufweist:

Einfache Montage
Unveränderte Frontanbindung
Stabilität
Hygiene
Individualität
Vielseitigkeit
Optimierter Installationsraum

For all drawers from 2 levels height, HAILO offers individual designs & solutions. Newly developed HAILO-system, patented, with various advantages:

Easy Installation
Usual Front - Adjustment and Attachment
Stability
Hygiene
Individuality
Flexibility
Optimized Installation Area

Individuelle Bestückung

Eimer mit Ordnungs- und Reinigungssystemen. Abfallbehälter, Universalbehälter, Kehrsetz uvm.

Optimale Stauraumnutzung

Abfalltrennung, Ordnungsutensilien übersichtlich, griffbereit zur Hand.

Geschlossenes System der Eimeraufnahme

Fehleinwurf wird verhindert. Glatte Reinigungsflächen.

Einstellbarkeit des Auszugs

Herkömmliche Einstellbarkeit der Front bleibt erhalten. Es werden keine weiteren Befestigungswinkel benötigt.

Einfache Montage,

bewährte Frontanbindung.

Individual Configuration

Bins, organizer, and cleansers-inserts.

Optimized utilisation of space.

Recycling- and Organizer-Center

Closed upper frame flush surfaces.

No miss-hits. No mess.

Smooth surfaces for cleaning.

Usual Attachment and Adjustment of front-panel.

No any further brackets required.

Easy Installation - usual front attachment.

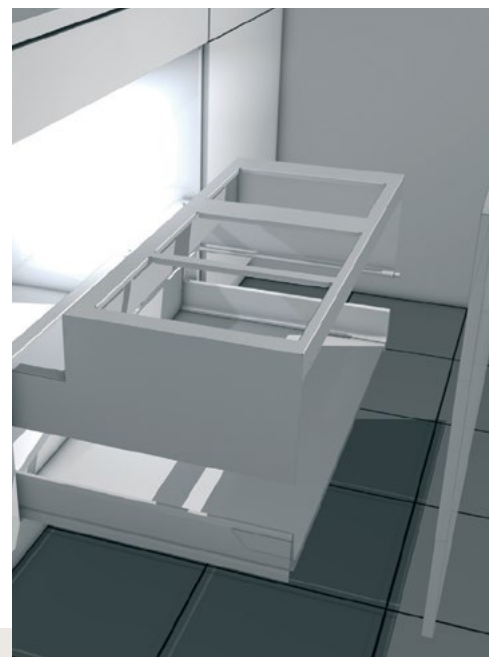
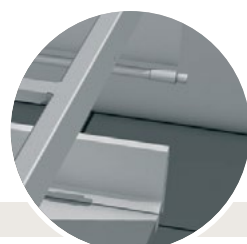

Speziallösungen für den Großraum-Sockelauszug.

Special solutions for high-capacity Plinth Drawers.

HAILO Sockel Cargo. HAILO Plinth Drawer Cargo.



Optimale Raumausnutzung und ideale Ausgestaltung des Sockelschubkastens.
Inkl. Nutzung des Sockelraumes.

Optimale Stauraumnutzung
inkl. Nutzung des Sockelraumes.

Geschlossenes System der Eimeraufnahme
Fehleinwurf wird verhindert.
Glatte Reinigungsflächen.

Einstellbarkeit des Auszugs
wird durch das System nicht beeinträchtigt.

Einfache Montage,
bewährte Frontanbindung.

Optimized utilisation of available space, and ideal use of plinth-drawer, including use of plinth-area.

*Makes the best use of storage space
Also utilises space behind plinth for storage.*

*Closed bins frame, flush surfaces,
easy to clean. No miss-hits.
No mess. Smooth surfaces for cleaning.*

*Adjustment of pull-out
is still be maintained.*

*Easy Installation,
usual front-attachment.*



30 cm

40 cm

45 cm

50 cm

60 cm

80 cm

90 cm

Inch

Inhaltsübersicht. Contents.

Abfallsammler. Waste bins		Artikel-Nr.	Seite	Abfalltrennsysteme. Waste separation systems.		Artikel-Nr.	Seite
Mono				Cargo Aqua			
Mono 12 Edelstahl/schwarz	<i>stainless steel/black</i>	3512031	46	NEW Cargo Aqua 600 13/13/D		3608601	122
Mono 12 weiß	<i>white</i>	3512001	46	NEW Cargo Aqua 600 28		3608611	122
Mono 15 Edelstahl/schwarz	<i>stainless steel/black</i>	3515031	48	NEW Cargo Aqua 750 28/18		3608751	142
Mono 15 weiß	<i>white</i>	3515001	46	NEW Cargo Aqua 900 28/13/13/D		3608901	156
Mono 15 Edelstahl/weiß	<i>stainless steel/white</i>	3515011	48	Cargo Soft			
Mono 15 dunkelgrau/schwarz	<i>dark grey/black</i>	3515071	48	Cargo Soft short 450 14/14		3610481	78
NEW Mono 20 Edelstahl/schwarz	<i>stainless steel/black</i>	3520001	50	Cargo Soft short 500 20/14		3610581	100
				Cargo Soft short 600 20/10/10/D		3610681	122
ÖkoFlex				Cargo Synchro			
Duo 8/8 Edelstahl/schwarz	<i>stainless steel/black</i>	3416101	70	Cargo Synchro 300 30		3608311	32
Duo 8/8 weiß	<i>white</i>	3416001	70	Cargo Synchro 450 18/18		3608471	74
Duo 8/8 Edelstahl/weiß	<i>stainless steel/white</i>	3416901	70	Cargo Synchro 450 55		3608461	74
Pico 5		3505001	28	Cargo Synchro 500 18/13/13/D		3608531	96
Uno 18 Edelstahl/schwarz	<i>stainless steel/black</i>	3418101	68	Cargo Synchro 500 28/18		3608521	96
Uno 18 weiß	<i>white</i>	3418001	68	Cargo Synchro 600 28/13/13/D		3608631	116
Uno 18 Edelstahl/weiß	<i>stainless steel/white</i>	3418901	68	Cargo Synchro 600 28/28		3608621	116
Solo				Easy Cargo			
Solo 20 automatic		3636001	44	Easy Cargo 42		3668401	50
Solo 20 manual		3635001	26	Easy Cargo 42		3668421	50
Wertstoffbox				Euro Cargo			
Wertstoffbox	<i>Built-in recycling bin</i>	3273101	64	Easy Cargo 30/19		3668501	90
Abfalltrennsysteme. Waste separation systems.				Euro Cargo			
Allegro System				Euro Cargo 300 38/7 dunkelgrau / <i>dark grey</i>			
NEW Allegro 220 14/14		3301611	134	Euro Cargo 400 38/7		3669101	38
NEW Allegro 220 14/6,5/6,5/D		3301621	134	Euro Cargo 450 38/38		3619421	60
NEW Allegro 295 18/8/8/D		3301631	136	Euro Cargo 450 38/38 dunkelgrau / <i>dark grey</i>		3619471	76
NEW Allegro 295 18/18/8/8/D		3301641	136	Euro Cargo 500 38/38		3619731	74
NEW Allegro 350 28/28		3301651	136	Euro Cargo 500 38/38 dunkelgrau / <i>dark grey</i>		3619531	98
NEW Allegro 350 28/13/13/D		3301661	138	Euro Cargo 500 38/38/12/D/2,5		3619721	96
NEW Allegro 380 28/28		3301671	138	Euro Cargo 600 38/38/12/D/2,5 dunkelgrau / <i>dark grey</i>		3619621	118
NEW Allegro 380 28/13/13/D		3301681	138	Euro Cargo 600 38/38/12/D/2,5 dunkelgrau / <i>dark grey</i>		3619771	116
Bottom Mount				Euro Cargo S			
Bottom Mount 400 24/D/24/D		3616411	60	Euro Cargo S 300 30		3610121	32
Bottom Mount 400 29/D/29/D		3616401	60	Euro Cargo S 450 19/19		3610471	76
Cargo				Euro Cargo S 500 30/19		3610521	98
Cargo 300 15/10/D		3610871	32	Euro Cargo S 600 30/30		3610621	120
Cargo 450 21/17		3610811	76	Euro Cargo S 600 30/13/13/D		3610631	120
Cargo 500 28/17		3610821	98				
Cargo 500 17/13/13/D		3610831	100				
Cargo 600 28/28		3610841	118				
Cargo 600 28/13/13/D		3610851	118				
Cargo 600 13/13/13/D		3610861	120				

Abfalltrennsysteme. Waste separation systems.		Artikel-Nr.	Seite	Abfalltrennsysteme. Waste separation systems.		Artikel-Nr.	Seite
Raumspär Tandem				Triple XL			
	Raumspär Tandem 8,5/8,5/8,5/8,5/D	3643141	54		Triple XL 450 55	3631481	84
	Raumspär Tandem 18/18	3641121	52		Triple XL 450 18/18	3631491	84
NEW	Raumspär Tandem 18/18 dunkelgrau / dark grey	3641521	52		Triple XL 500 18/28	3631581	106
	Raumspär Tandem 18/18	3640001	56		Triple XL 500 18/13/13/D	3631591	106
	Raumspär Tandem 18/8,5/8,5/D	3642131	52		Triple XL 600 28/28	3631681	128
NEW	Raumspär Tandem 18/8,5/8,5/D dunkelgrau / dark grey	3642531	54		Triple XL 600 28/13/13/D	3631691	128
NEW	Raumspär Tandem 18/8,5/8,5/D schwarz / black	3642731	54		Triple XL 800 28/28/18	3631881	146
	Raumspär Tandem Comfort 20/10/10/D/KS	3642231	56		Triple XL 900 28/28/28	3631981	160
	Raumspär Tandem Comfort 20/20/KS	3641221	56	US Cargo			
	Raumspär Tandem S 18/12 dunkelgrau / dark grey	3644901	90		US Cargo 15" 37/15/D	3613311	166
	Raumspär Tandem S 12/8/8/D dunkelgrau / dark grey	3644911	92		US Cargo 18" 37/15/D	3613331	166
NEW	Raumspär Tandem S 12/8/8/D schwarz / black	3644931	92		US Cargo 21" 42/42	3613351	166
	Raumspär Tandem S 18/12	3644701	90		US Cargo 24" 42/42	3613371	168
	Raumspär Tandem S 12/8/8/D	3644731	92		US Cargo 15" 37/15/D	3613321	168
	Raumspär Tandem S plus 18/12	3644821	112		US Cargo 18" 37/37	3613341	170
	Raumspär Tandem S plus 18/12	3644801	112		US Cargo 21" 42/42	3613361	170
	Raumspär Tandem S plus 12/8/8/D	3644831	112		US Cargo 24" 42/42	3613381	170
Rondo				XXL			
	Rondo 18/18 ME	3645121	150		XXL 450 18/D/12/P/U	3630451	84
	Rondo 18/8/8/D/ME	3646131	150		XXL 500 12/8,5/8,5/D/P/P	3630501	106
	Rondo 8/8/8/8/D/ME	3647141	150		XXL 600 18/D/8,5/8,5/P/P	3630601	128
	Rondo Comfort 20/20/KS/ME	3645221	152		XXL 800 18/D/18/D/12/P/P/P	3630801	146
	Rondo Comfort 20/10/10/D/KS/ME	3646231	152		XXL 900 18/D/18/D/12/12/P/P/U/U	3630901	160
Separato K							
	Separato K 450 18/8/8/D	3620461	86				
NEW	Separato K 450 18/8/8/D dunkelgrau / dark grey	3620471	86				
	Separato K 500 18/8/8/D	3620511	108				
NEW	Separato K 500 18/8/8/D dunkelgrau / dark grey	3620521	108				
	Separato K 600 18/8/8/D	3620611	130				
NEW	Separato K 600 18/8/8/D dunkelgrau / dark grey	3620651	130				
NEW	Separato K 600 20/20	3620801	130				
NEW	Separato K 600 20/20 dunkelgrau / dark grey	3620811	132				
	Separato K 900 18/18/8/8/D/KS	3620901	160				
	Separato K 900 18/18/8/8/D/KS	3620911	162				
Tandem							
NEW	Tandem 13/13	3666901	42				
NEW	Tandem 28	3666911	42				
NEW	Tandem 8/8/8	3666921	42				
	Tandem 15/15 Black Edition	3666851	26				
	Tandem 15/15 dunkelgrau / dark grey	3650101	26				
	Tandem 15/15 dunkelgrau / dark grey	3669001	38				

Inhaltsübersicht. Contents.

Ordnungssysteme. Organizer Systems.

Carry Putzmittelauszug *Pull-out cleaning material rack*

Carry		3950001	204
NEW Carry2		3950551	204

Deposito Gewürzregal *Spice rack*

Deposito Regalsystem	Rack system	3981651	196
Deposito Regalsystem	Rack system	3981951	196

Haustierstation *Pet station*

Ablage dunkelgrau	Shelf dark grey	3271811	182
Ablage weiß	Shelf white	3271151	182
Futterstation Hund	Pet station Dog	3290001	180
Futterstation Katze	Pet station Cat	3291001	180

Micro Garden

Micro Garden		3970601	176
--------------	--	---------	-----

Pantry Box *Storage system*

Pantry Box		3960601	186
------------	--	---------	-----

Secco Handtuchhalter *Towel Rails*

Handtuchhalter	<i>Towel Rail with 2 bars</i>	3142901	190
Handtuchhalter	<i>Towel Rail with 3 bars</i>	3143901	192
Secco Handtuchhalter	<i>Towel Rail with 2 bars</i>	3132101	192
Secco Handtuchhalter	<i>Towel Rail with 3 bars</i>	3133101	192
NEW Secco S Handtuchhalter	<i>Towel Rail dark grey</i>	3151101	190
Secco S Handtuchhalter	<i>Towel Rail</i>	3151001	190

Vario Auszug-Utensilien-Depot *Pull-out utensil store*

Vario		3902001	200
Vario		3903001	200
Vario		3909001	200
Vario Einzelauszug	<i>Single pull-out tray</i>	3920001	200

Funktionssysteme. Functional systems.

Kick and Go

Kick and Go		3691301	212
Kick and Go		3692021	212

Libero

Libero 3.0		3697301	210
------------	--	---------	-----

Rapid

Rapid (Dekor Weiß)	<i>White</i>	3845601	216
Rapid (Dekor Edelstahl)	<i>Steel/alu brushed</i>	3845121	216

Stepfix Einbauklapptritt *Built-in Folding Step*

Stepfix		4410001	220
Sockelblendenhalter	<i>Plinth bracket Stepfix</i>	4496001	220
Wandhalter	<i>Universal bracket</i>	4495001	220

Hauswirtschaftsraum. Utility room.
Laundry Carrier

	Artikel-Nr.	Seite
Laundry Carrier 450	3270461	242
Laundry Carrier 450 dunkelgrau / <i>dark grey</i>	3270811	242
Laundry Carrier 500	3270551	242
Laundry Carrier 500 dunkelgrau / <i>dark grey</i>	3270851	244
Laundry Carrier 600	3270611	244
Laundry Carrier 600 dunkelgrau / <i>dark grey</i>	3270831	244
Laundry Carrier S 600	3270691	246
Laundry Carrier S 600 dunkelgrau / <i>dark grey</i>	3270841	246
Laundry Carrier 450 Bad <i>bathroom</i>	3270471	248
Laundry Carrier 600 Bad <i>bathroom</i>	3270621	248

Ordnungs-Module Organizer Modules

Ablage dunkelgrau <i>Shelf dark grey</i>	3271811	232
Ablage weiß <i>Shelf</i>	3271151	230
Anbau Wäschetrockner <i>Laundry Rack</i>	3271901	236
Besen-/Wischerhalter <i>Broom/Wiper Holder</i>	3271821	232
Besen-/Wischerhalter weiß <i>Broom/Wiper Holder</i>	3271251	232
NEW Flaschenhalter dunkelgrau <i>Bottle holder dark grey</i>	3273631	238
NEW Getränkeboxenhalter <i>Beverage crate holder</i>	3273611	238
Multifunktionshalterung <i>Multifunctional Holder</i>	3272181	234
Multifunktionshalterung weiß <i>Multifunctional Holder</i>	3272161	234
Set Shoe Rack <i>Set Shoe Rack</i>	3271000	230
Set Shoe Rack <i>Set Shoe Rack</i>	3272000	228
Set Universaltablar <i>Set Universal Pullout</i>	3271002	228
Set Universaltablar <i>Set Universal Pullout</i>	3272002	226
Shoe Rack	3271661	230
NEW Universalablage dunkelgrau <i>Universal tray dark grey</i>	3273621	238
Universaltablar weiß <i>Universal Pullout</i>	3271351	226
Universaltablar <i>Universal Pullout</i>	3271831	226
2 Utensilienbehälter <i>2 Accessories Boxes</i>	3271501	236
2 Utensilienbehälter <i>2 Accessories Boxes</i>	3271841	236
Wäschekorb, blau <i>Laundry basket blue</i>	3271361	228
Wäschekorb, weiß <i>Laundry basket white</i>	3271381	228
NEW Wertstoff Depot dunkelgrau <i>Collector dark grey</i>	3272121	234
Wertstoff Depot weiß <i>Collector</i>	3272111	234

Zubehör. Accessories.

	Artikel-Nr.	Seite
Kitty hellgrau/dunkelgrau <i>light grey/dark grey</i>	3204101	270
On Top Behälter <i>Container</i>	3205101	270
Schlauchbrausenabweiser <i>Wall-Bracket for Flex-Hose</i>	3693001	270

Übrigens, wussten Sie, ...

By the way, did you know ...

... dass HAILO bereits in der Gründungszeit 1947 Abfallsammler produzierte?
... *that HAILO has been producing waste bins right from the outset, early 1947?*

... dass die Marke HAILO in Deutschland einen Bekanntheitsgrad von etwa 68 % besitzt?
... *that the HAILO brand enjoys a recognition factor of approx. 68% in Germany?*

... dass HAILO im Verzeichnis „Marken des Jahrhunderts“ neben anderen 300 Premiummarken vertreten ist?
... *that HAILO is amongst 300 premium brands listed in the “Brands of the Century” guide?*

... dass HAILO bereits in den 50er-Jahren als erstes Unternehmen einen Einbau-Ausziehtisch für Küchenmöbel auf den Markt brachte?
... *that HAILO, as the first company, introduced a built-in pull-out table for kitchen base-cabinets in the 1950s?*

... dass HAILO Einbautechnik weltweit in über 80 Länder exportiert?
... *that HAILO Built-In Technology exports to more than 80 countries around the world?*

... dass HAILO bereits 1953 den ersten Einbau-Abfallsammler für Küchen auf den Markt brachte?
... *that HAILO already introduced the first built-in waste bins in 1953?*

... dass der HAILO Rondo das erste ganzheitliche Abfalltrenn- und Ordnungssystem für Eckspülenschränke war und bis heute als das Original schlechthin gilt?
... *that the HAILO Rondo is the first integrated waste separation and order system for corner sink units and is still regarded as the original today?*

... dass HAILO bereits 1993 ein Abfalltrennsystem mit Frontanbindung und Auszugschienen auf den Markt brachte und somit als Pionier dieser Systeme gilt?
... *that HAILO as a pioneer launched a waste separation system with front attachment and drawer slides in 1993?*



Platz für Notizen:

Space for your notes:

